

# EFFECTS OF HOT ISOSTATIC PRESSING ON THE TENSILE PROPERTIES OF A356 CAST ALLOY

S. M. Mostafavi Kashani<sup>1</sup>, H. Rhodin<sup>1</sup> and S. M. A. Boutorabi<sup>2,\*</sup>

\* *boutorabi@iust.ac.ir*

Received: January 2013

Accepted: July 2013

<sup>1</sup> Lund University, Sweden.

<sup>2</sup> School of Metallurgy and Materials Engineering, Iran University of Science and Technology, Iran.

**Abstract:** The influences of age hardening and HIP (Hot Isostatic Pressing) on the mechanical properties of A356 (Al 7Si 0.6 Mg) casting alloys were studied. Cast bars were homogenized, heated and maintained at a temperature of 540°C for a duration of 2 hours, followed by rapid cooling in a polymeric solution. The castings were age hardened at 180°C for a duration of 4 hours before being subjected to HIP process at pressure of 104 MPa for 2 hours. The results indicated that the age hardening process used improved the tensile properties of A356. The HIP process removed the internal surface-connected porosities and improved the ductility of the samples significantly. Additionally, HIP reduced scattering in the tensile test data.

**Keywords:** Hot Isostatic Pressing; Elongation; Surface Connected Porosity.

## 1. INTRODUCTION

Hot isostatic pressing is used in various industries for the production of multi-material components, especially components used in highly loaded power machines [1-7].

HIP was industrially introduced as a process to obtain up to 100% density material. Presently, HIP has found applications efficiently used in industrial areas. These include the production of quality parts made of powder, complex “near-net-shape” parts made of expensive and hardly-machined materials, and parts of various compositions with properties rationally distributed [8].

HIP is gathering a lot of attention as a manufacturing method for ceramics with high performance and high reliability. A vast amount of theoretical studies as well as experimental works concerning the properties of ceramics and metallic materials have been conducted. These investigations include the practical removal of casting cracks, the reclamation of damaged parts due to fatigue/creep, solid diffusion welding, etc. However, reports [9] discussing results of HIP are few, thus publications are desired.

In 2008, Ceschini et al. reported that HIP has a negligible effect on microstructural features such as grain size, SDAS, and intermetallic

compounds, whereas it significantly reduces the solidification defects in A356-T6 alloy[10]. Further, the result of Rand et al. (2006) indicated that the HIP process significantly reduces porosity volume fraction, and pore size, and improves ductility in A356-T6 alloy[11].

In the present study HIP annealing process was applied to Al7Si0.6Mg casting alloy resulting in a new family of this alloy with new mechanical properties.

## 2. EXPERIMENTAL PROCEDURE

### 2.1. Melting and Casting

A356 Al cast bars were melted in a 50Kg capacity high frequency induction furnace. The melts were cast at two temperatures of 650°C and 750°C in standard moulds with 1.5, 2.5, 3.5 and 6.5mm gauge-lengths. Silica sand was mixed with 2% furan resin and 0.6% phosphoric acid according to AFS60 standards. Figure 1 illustrates the bar and the mould. To produce sound casting, the critical gate velocity rules were considered [12-17].

### 2.2. Porosity Measurement

Test bars were cut to a length of 160mm and

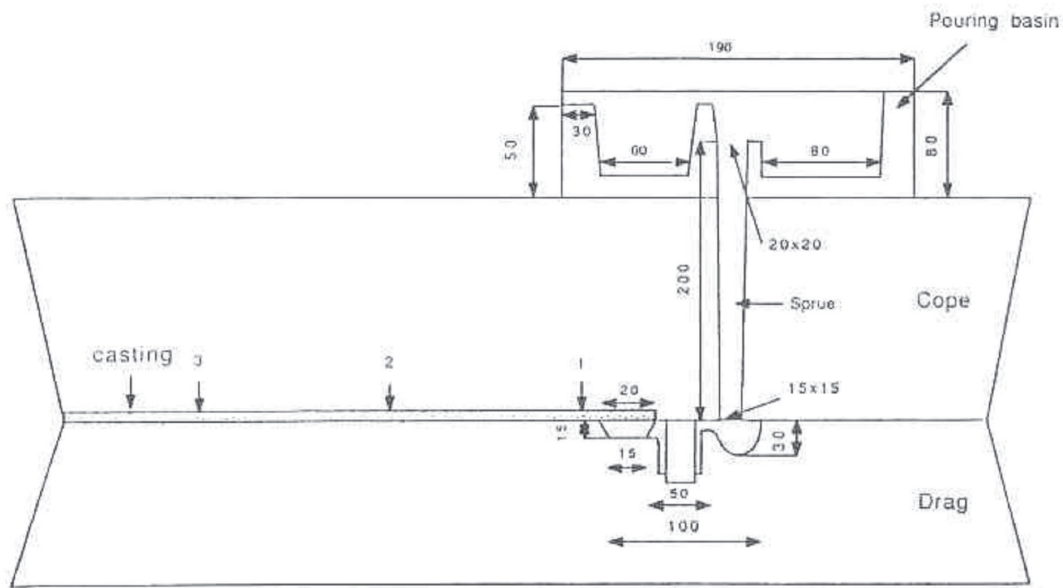

Fig. 1. The bar and mould, sized in mm

the percentage of the porosities was determined using the relation

$$\% \text{Porosity} = (DS - D) / D$$

where DS and D are densities of bars in as-cast and hipped conditions respectively.

### 2. 3. Age Hardening

Test bars were solution treated at 540°C for 2 hours, cooled in a polymeric solution, and age hardened at 180°C for 4 hours. The fluctuation of temperature was maintained in the range of ±4°C.

### 2. 4. HIP (Hot Isostatic Pressing)

HIP was conducted to eliminate porosities. During this process, the temperature was slowly raised to 500°C. Simultaneously, the pressure in the chamber was slowly raised to 104 MPa and maintained for a duration of 2 hours. The pressure was decreased and the temperature of the chamber was reduced to ambient temperature before opening the door.

### 2. 5. Mechanical Properties

Tensile tests were conducted using an Instron

Machine with a speed of 2 mm.min<sup>-1</sup> on the specimens which were used in the porosity measurements.

## 3. RESULTS AND DISCUSSION

The variations of tensile strength and proof stress values as a function of density and density/density<sup>o</sup> (density ratio of A356) in as-cast A356 alloy are displayed in Figure 2 and Figure 3, respectively. Samples cast at 650°C indicated higher UTS and PS in comparison to samples cast at 750°C. This can be due to finer structure of samples cast at 650°C or smaller size of secondary DAS (Dendrite Arm Spacing). Further, UTS increases with density. Figures 4, 5, 6, and 7 respectively show the UTS, PS, El% (Elongation %) and RA% (Reduction in Area %) values as a function of porosity. The range of UTS in age hardened samples indicates increasing values due to the precipitation and distribution of Mg<sub>2</sub>Si within the grains. The HIP process removed the volume fraction of the surface connected porosities (Figures 8 and 9), and as a consequence mechanical properties of the castings showed a better consistency (Figures 4 and 5).

El% and RA% values indicate a considerable increase when HIP is applied to the castings (Figures 6 and 7). This might be due to the

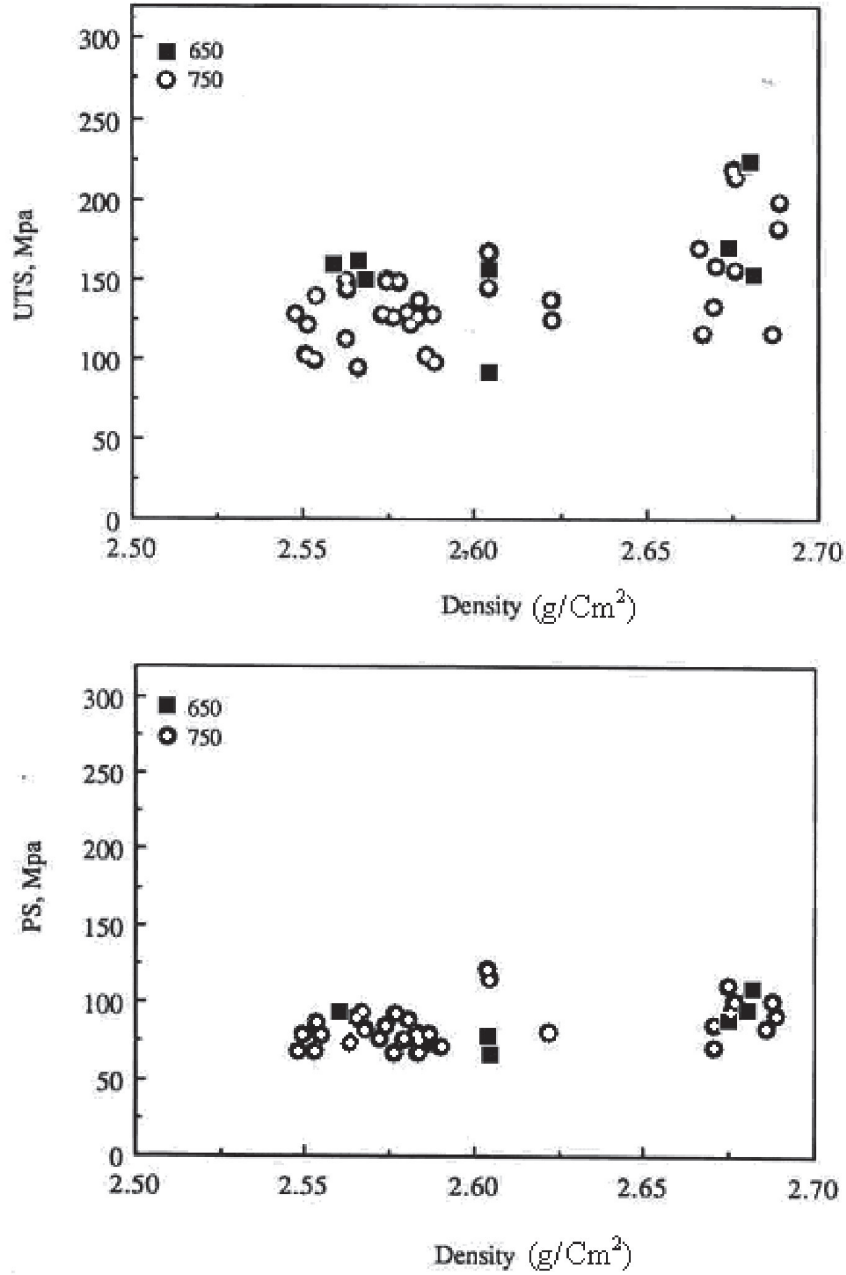

Fig. 2. The variations of UTS and PS values as a function of density in A356 samples cast at 650 and 750°C.

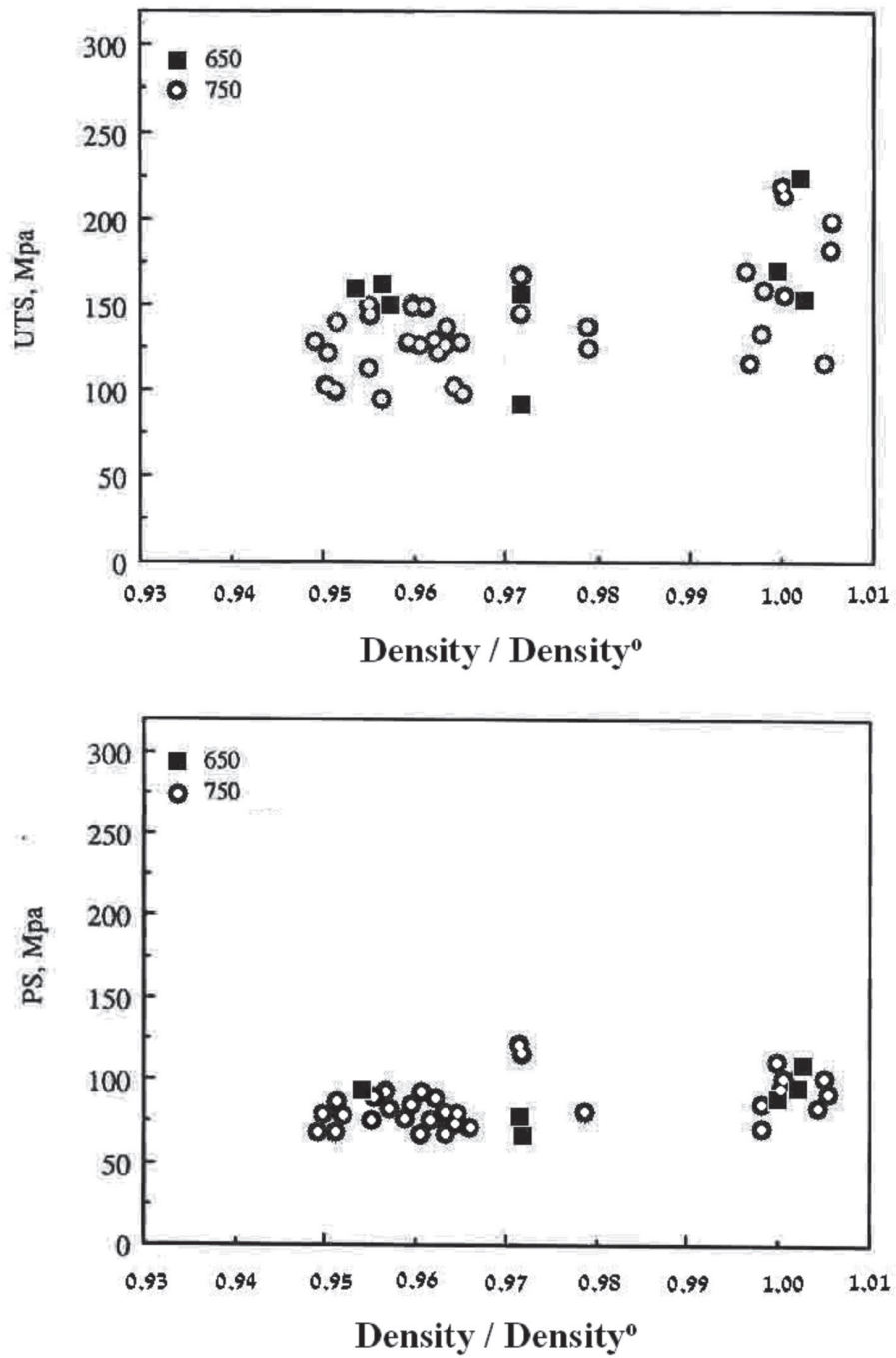

Fig. 3. The variations of PS values as a function of "density / density <sup>0</sup>" in A356 samples cast at 650 and 750°C

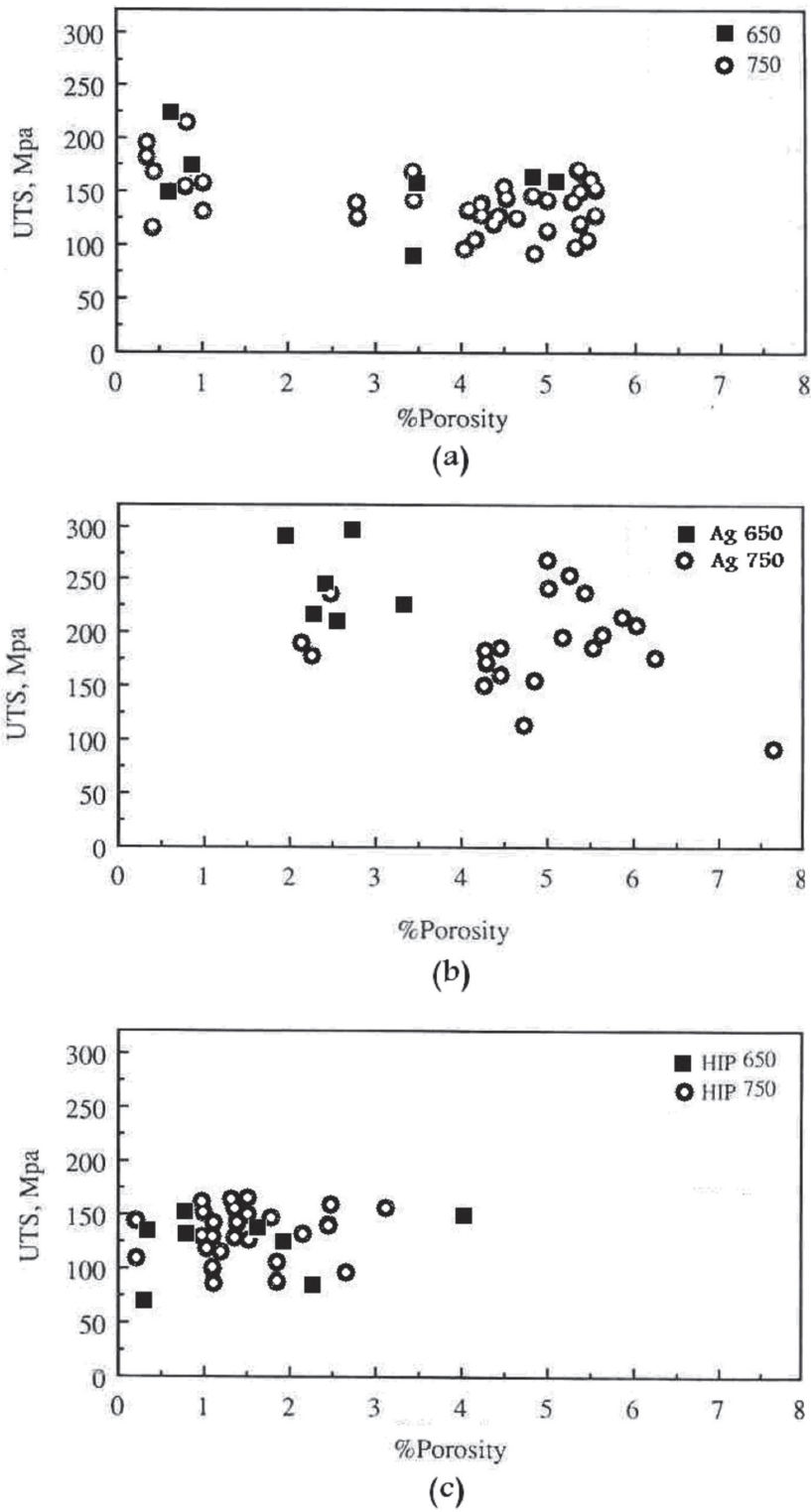

Fig. 4. The variations of UTS values as a function of porosity in A356 specimens.  
a) as-cast; b) age hardened; c) hipped specimens.

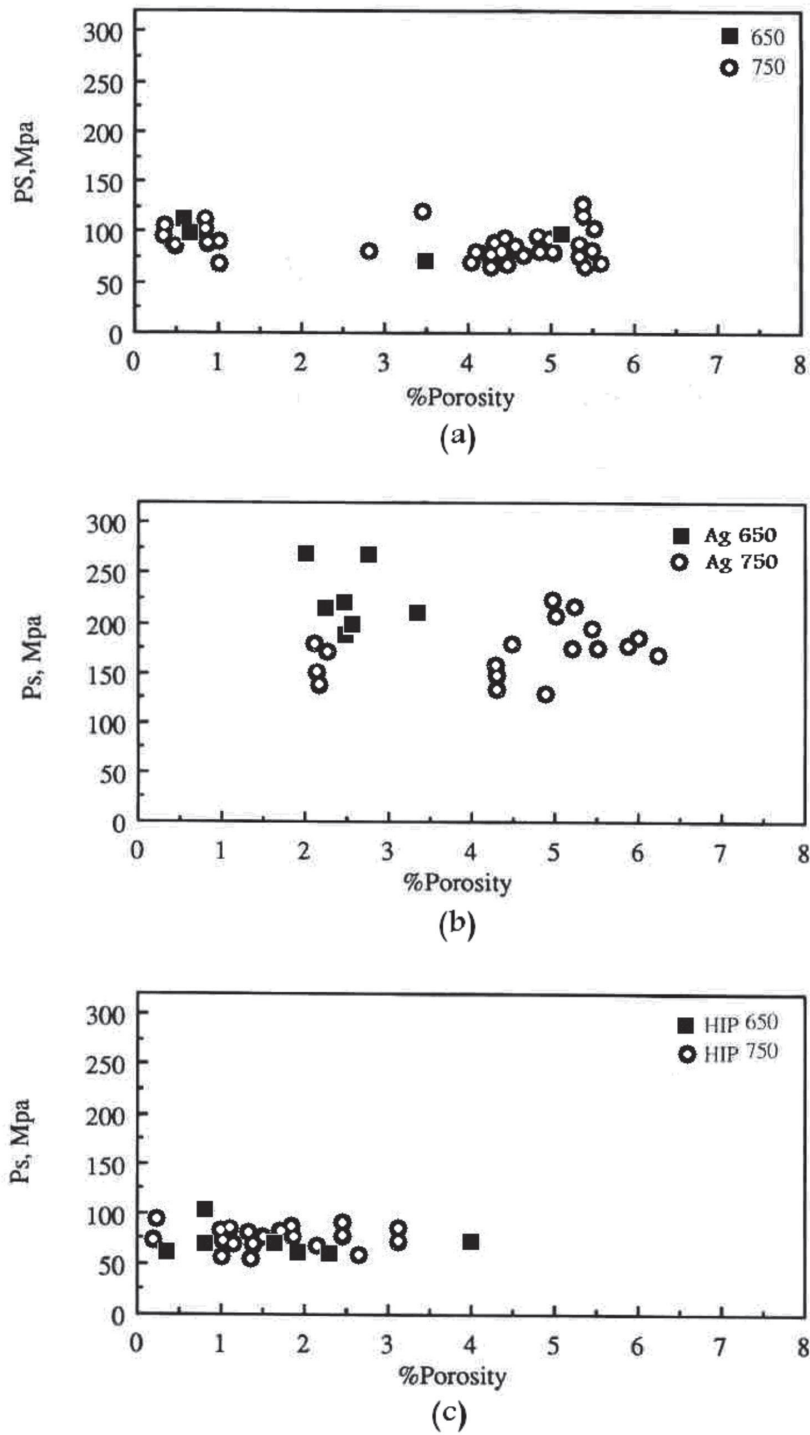

Fig. 5. PS values as a function of porosity in A356 specimens.  
a) as-cast; b) age hardened; c) HIPed samples.

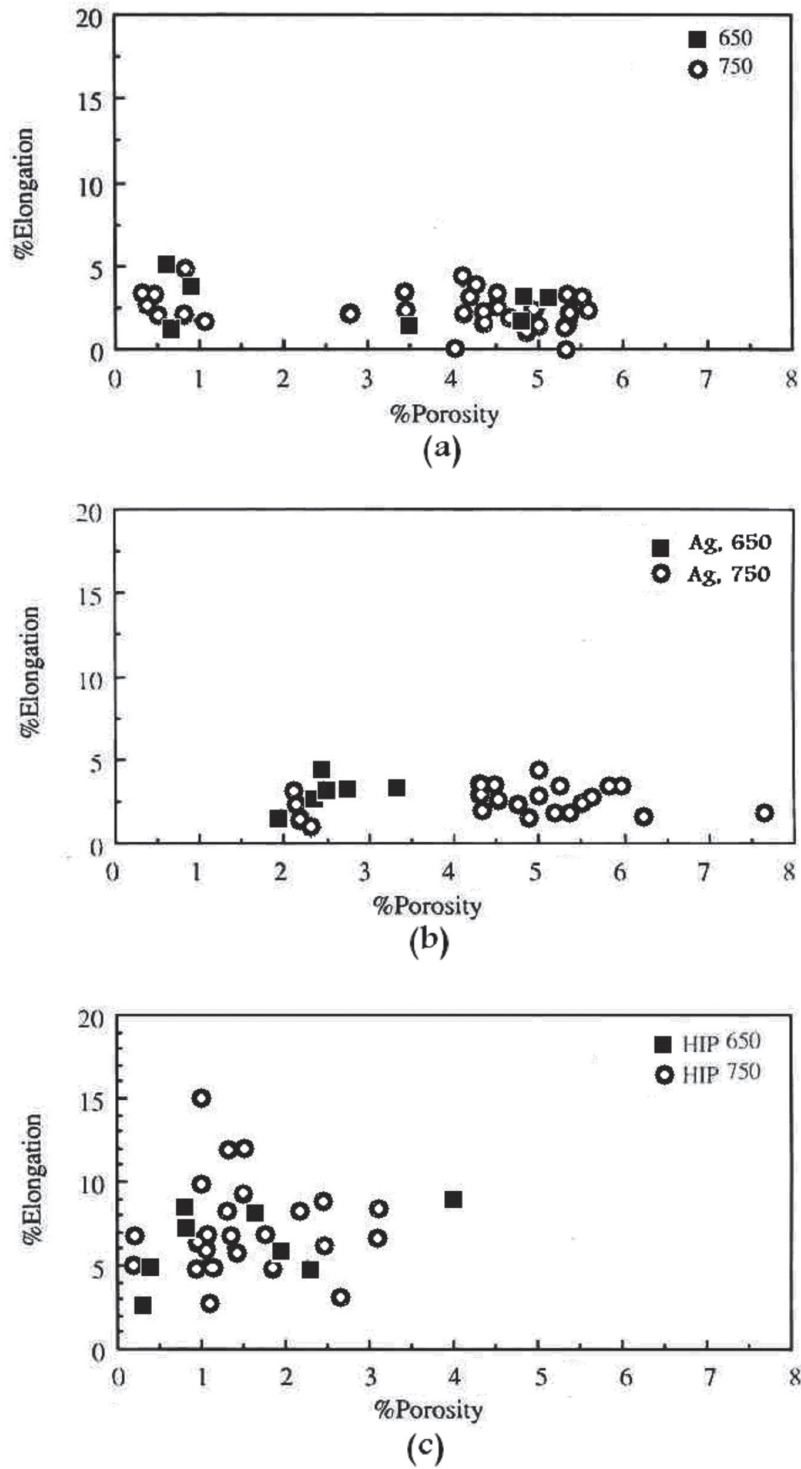

Fig. 6. El% values as a function of porosity in A356 specimens.  
a) as-cast; b) age hardened; c) hipped samples.

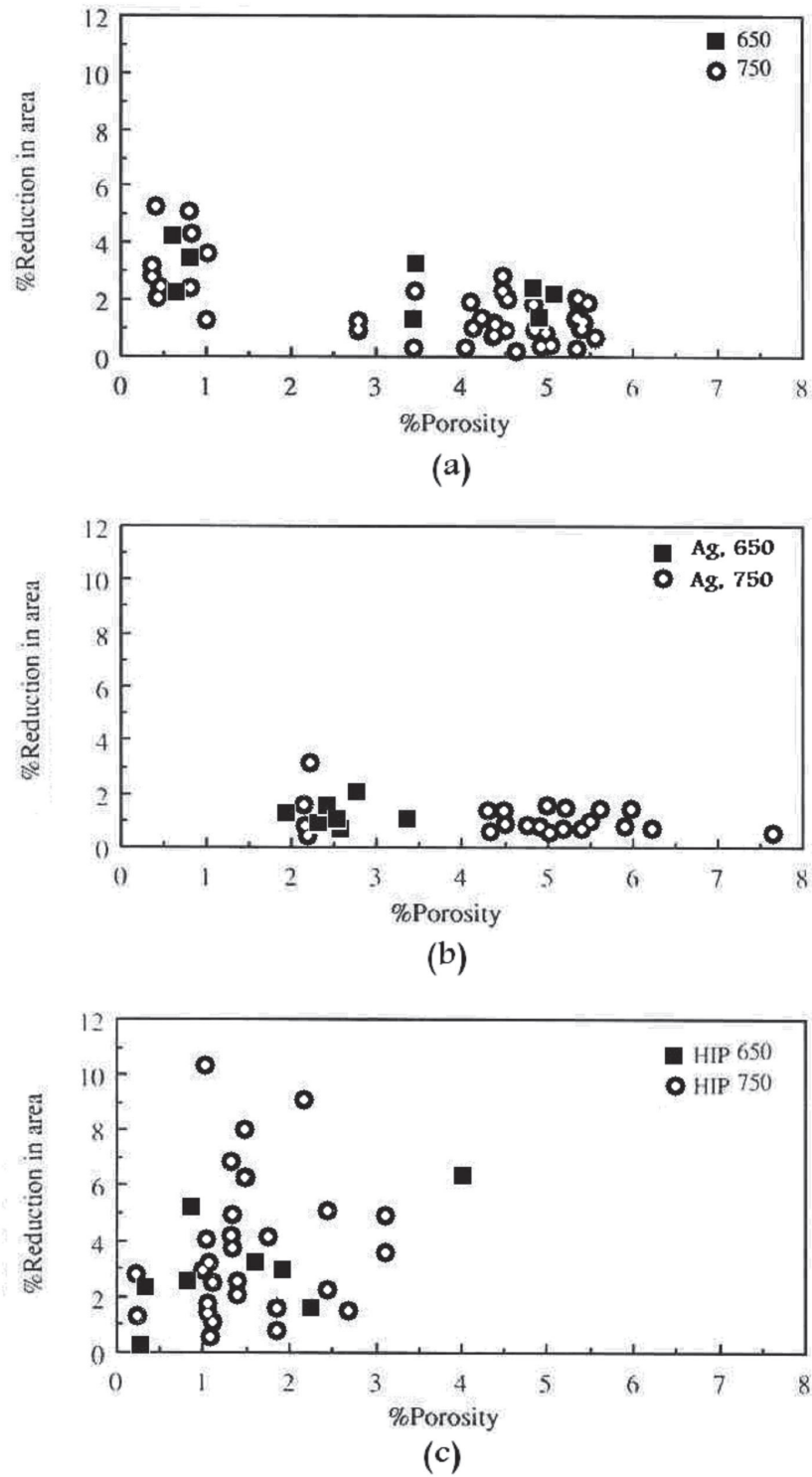

Fig. 7. RA% values as a function of porosity in A356 specimens.  
a) as-cast; b) age hardened; c) hipped samples.



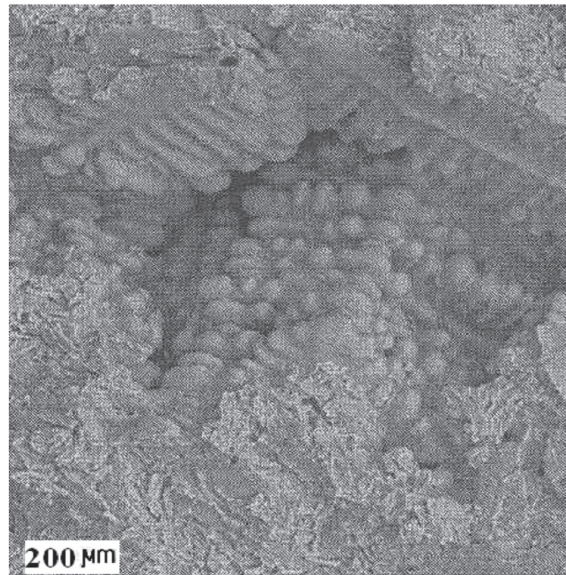

Fig. 8. SEM image of as-cast A356 sample, showing a porosity formed in interdendritic area,  $\times 200$

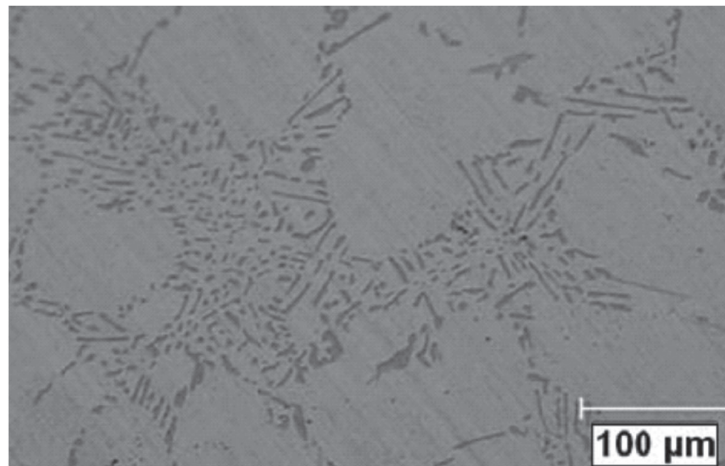
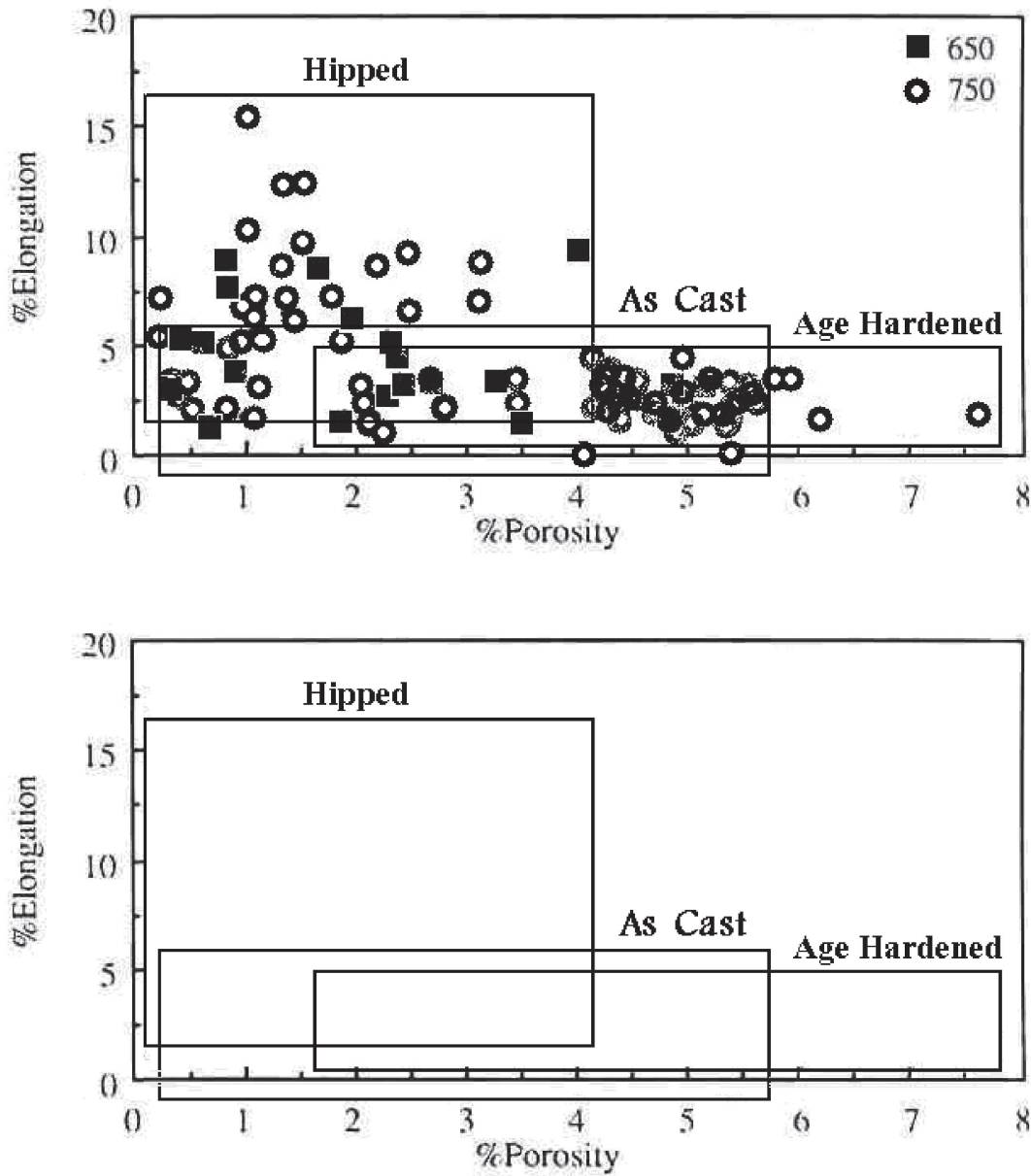

Fig. 9. The optical micrograph of as-cast A356 sample, showing the squeezed porosities in a dendritic structure. The preparation method was as is sequenced: 1) cutting the samples out of the cast bars, 2) hard and soft grinding, 3) polishing using  $0.3 \mu\text{m}$  alumina powder, 4) etching by HF (0.5%) diluted in 100 ml of distilled water

removal of the internal porosities which were connected to the surface (surface-connected porosities). The porosity reduction from 2-8% to 0-4% can be seen in Figures 5 and 6.

The investigations on the powder moulded copper and stainless steel alloys show that the density ratio reaches up to 95% when HIP is applied [18].

As stated previously, the HIP process removes surface-connected porosities, resulting in an increase of the elongation. Figure 10 shows a general map of the elongation values in the as-cast and age hardened conditions. The diagram clearly illustrates the increase of elongation due to porosity reduction as a result of HIP.



**Fig.10.** The general behavior of the variations of elongation as a function of porosity due to HIPping, showing sharp decrease in porosity and sharp increase in elongation.

#### 4. CONCLUSIONS

1. There are large variations in the mechanical properties of the as-cast, age hardened and hipped A356 cast alloys.
2. The elongation shows considerable changes when hipped at 500°C under 104 MPa pressure.
3. UTS and PS values did not show a significant change after HIP.
4. A new family of A356 with 16% elongation can be introduced to the industry by hipping the A356 cast alloy.

## REFERENCES

1. Closset, B., and Gruzleski, J. E., "Mechanical Properties of A356.0 Alloys Modified with Pure Strontium", AFS Transactions 90, pp. 453-464. 1982,
2. Closset, B., and Gruzleski, J. E., "Structure and properties of hypoeutectic Al-Si-Mg alloys modified with pure strontium", Metallurgical Transaction A 13A, pp. 945-951.1982,
3. Argo, D., and Gruzleski, J. E., "Porosity in Modified aluminum Alloy Castings", AFS Transactions 96, pp 65-73.
4. Pelguleryuz, M., and Gruzleski, J. E., "AFS Transactions 96", pp. 55-64. 1982,
5. Gruzleski, J. E., and Closset, B., "The treatment of liquid Al-Si Alloys, AFS", inc., Des Plaines, Illinois. 256 p. 1990,
6. Pierronnet, M., Raisson, G., "Production of clad and bimetal components by HIP assisted diffusion bonding of steels and superalloys", proceeding of the 4th International Conference on Isostatic Pressing, Stratford-upon-Avon. November 5-7 1990,
7. Raisson, G., and Buekenhout, L., "The manufacture of wear resistant parts by hot isostatic pressing", 28th Special Steel Days, Liege. May 24-25 1989,
8. Kratt, E. P., Samarov, V. N., and Haykin, R. A., "Technology of HIPing Complex Shape Parts with Dual Chemical Composition and Properties from Metal Powders: Trends of Its Development in the USSR, Hot Isostatic Pressing-Theory and Applications", Proceeding of the Third Conference Osaka, Japan, Elsevier Applied Science London and New York. 10-14 June 1991,
9. Ona, H., Ichikawa, S., Annodou, T., and Nishioka, A., "HIPing Effects for Steel's Mechanical Properties, Hot Isostatic Pressing-Theory and Applications Proceeding of the Third Conference Osaka", Japan, Elsevier Applied Science London and New York. 10-14 June 1991,
10. Ceschini, L., Morri, A., and Sambogna, G., "The effect of HIP on the fatigue behaviour of sand-cast A356-T6 and A204-T6 aluminum alloys", Journal of Materials Processing Technology 204, pp. 231-238. 2008,
11. Ran, G., Zhou, J., and Wang, Q. G., "The effect of HIP on the microstructure and tensile properties of an unmodified A356-T6 cast aluminum alloy", Journal of Alloys and Compounds 421, pp. 80-86. 2006,
12. Campbell, J., "Castings, Oxford: Butterworth Heinemann Ltd.", 1991, and paperback ed. 1993,
13. Campbell, J., "Some Recent Developments in the Aluminum Casting Industry", Cast Metals Vol. 1, No.3, pp 156-160.1988,
14. Campbell, J., "The Ten Rules Oxford. Butterworth". Heinemann.2003,
15. Boutorabi, S. M. A., Kazazi, G., Nafisi, S., and Mosleh, B., "A New Approach to Gating System", Casting Research Centre of I.U.S.T. (Iran University of Science and Technology), Tehran.1998,
16. Murphy, A. J., "Non-Ferrous Foundry Metallurgy", Pergaman Press, London. 1954,
17. Jain, P. L., "Principles of Foundry Technology", Tata Mc Graw-Hill Pub., New Delhi.1979,
18. Koizumi, M., and Nishihara, M., "Isostatic Pressing Technology and Applications", Elsevier Science Publishers LTD., Britain. 1991,