

THE EFFECT OF METAKAOLIN, SILICA FUME AND NANOSILICA ON THE MECHANICAL PROPERTIES AND MICROSTRUCTURE OF CEMENT MORTAR

H. R. Sobhani Kavkani¹, A. R. Mortezaei¹ and R. Naghizadeh^{2*}

* rnaghizadeh@iust.ac.ir

Received: October 2015

Accepted: February 2016

¹ Civil Engineering Department, Semnan Branch, Islamic Azad University, Semnan, Iran.

² School of Metallurgy and Materials Engineering, Iran University of Science and Technology, Tehran, Iran.

Abstract: Different mineral admixtures of Indian metakaolin, Iranian silica fume and nanosilica were used to produce high performance mortars. Two different sands types with grain size of 0.015-4mm were mixed with type II Portland cement, polycarboxylate superplasticizer, mineral admixture with 650kg/m³ cement content and water/cement ratio of 0.35. Different amount of cement was replaced by metakaolin or silica fume (5-15wt%) or nanosilica (0.8-5wt%). After mixing, moulding and curing, compressive strength, electrical resistivity and abrasion resistance were studied. The maximum compressive strength of 28 days samples were 76MPa, 79MPa and 75MPa for 15wt% substitution of cement with metakaolin, silica fume and 5wt% with nanosilica. The compressive strength of these samples showed 28%, 33% and 26% increment in comparison with reference sample, respectively. X-ray patterns showed that replacing silica fume leads to reduction of Portlandite (Ca(OH)₂) phase. This can be attributed to the pozzolanic reaction and formation of new hydrated calcium silicate phase (CSH) that caused improvement of strength of admixtures containing samples. The microstructure of silica fume containing sample also showed better bond between sand and matrix. The electrical resistivity of samples with 15wt% metakaolin or silica fume and 5wt% nanosilica reach to 21kΩ.cm, 15 kΩ.cm and 10kΩ.cm, respectively. These samples showed high durability and corrosion resistance relative to reference samples (3.4 kΩ.cm). The abrasion resistance of different admixtures, specially silica fume containing samples were improved.

Keywords: Metakaolin, Silica fume, Nanosilica, Cement mortar.

1. INTRODUCTION

Cement is one of the important consuming materials in the world. However, environmental challenges with high extraction of natural raw materials and CO₂ emission during cement manufacturing (about 7% worldwide CO₂ emission), brought forces to decrease cement consumption by usage of supplementary materials [1]. The world cement clinker production was 3.4 billion tons at 2013, that china with 1.9 billion tons, India with 280 million tons, America with 105 million tons and Iran with 80 million tons were contributed at these production as four major manufacturers [2]. In some countries such as Nigeria approximately 40-50% cement manufacturing cost is related to the energy, 60-130 kg of fuel oil and about 105 kWh of electricity are consumed for production of one tons of cement. Thus, with substitution of supplementary materials in cement and concrete

production, the total consumption of energy is also decreased [3].

High performance concretes were developed by selecting appropriate materials (cement, sand,...), properly mixing, transportation, placing, consolidating and curing. This conclude in a concrete with high and super high compressive strength (45-800 MPa after 28 days), high bending strength, high durability under chloride and/or sulfate ions penetration, engineered cementitious composites with tensile strain-hardening and frost resistance [4]. These improvements obtained with chemical and/or mineral admixtures, fibers (steel, poly-vinyl-alcohol), and nanomaterials. Admixture are those ingredients in concrete that are added to the mixture of cement, fine and coarse aggregate (sand and gravel), water immediately before or during mixing that classify to chemical, mineral and coloring additives. Chemical admixtures have functions such as air-entraining (such as

alkylbenzene, sulfonates), water reducing (such as lignosulfonates), retarders (such as sugars), accelerators (such as calcium nitrate), super plasticizers (such as lignosulfonates) and some miscellaneous ones; such as antiwashout, foaming and pumping admixtures [5,6]. Mineral admixtures are finely ground natural, synthesis, waste and by-product materials that are used in relatively large amount in comparison with chemical types. They are replaced with cement and/or fine aggregates in mortar or concrete. These materials are divided in two groups; pozzolanic and inert filler. Natural volcanic pozzolan, fly ash (non-combustible glassy particle of coal), silica fume or microsilica (by-product of silicon or ferro-silicon production), rice-husk ash (an agricultural waste), ground granulate blast-furnace slag and metakaolin have reactive silica or alumino-silica that consumed Portlandite ($\text{Ca}(\text{OH})_2$) and established calcium silicate hydrate phase (CSH)[7,8]. In recent years, nanosized particles were used in concrete technology as in bulk and surface application to improve chemical and mechanical properties. In bulk application, nanomaterials can improve strength, elastic modulus, rate of hydration and prevent crack initiation at concrete [9]. A wide range of studies have been done on the usage of Fe_2O_3 , TiO_2 , Cr_2O_3 , ZrO_2 , CaCO_3 , nanoclay, carbon nanotubes and specially SiO_2 in cement

and concrete. Nano- TiO_2 and Ag were used to modify surface properties of concrete such as photocatalytic, self-cleaning, and water repellent surfaces [10]. Nano-silica has different performances in cement based materials such as improvement of bond between aggregates and cement paste, consumption of $\text{Ca}(\text{OH})_2$, formation of an additional small size C-S-H phases (pozzolanic reactions), acting as cores for cement hydrates crystallization (accelerating hydration) and improvement of cement based materials toughness [11]. The effect of mineral admixtures such as metakaolin, silica fume and nanomaterials such as nanosilica on the compressive strength is well documented [12-13]. In this study, nanosilica, silica fume and metakaolin were used as supplementary additives to improve strength and microstructure of cement mortars. Moreover, for better understanding of properties correlation electrical resistivity and abrasion resistance tests were done on different pastes.

2. EXPERIMENTAL FRAMEWORK

2.1. Materials

Commercial type II cement was used in this research (according to ASTM C150-97) which was obtained from Faraz Firouzkoh Cement Co.

Table 1. Chemical composition and physical properties of type II, Faraz Portland cement

Chemical composition (wt. %)		Physical properties
CaO	61.28	Specific surface area (ASTMC204): Blain: 2900 cm^2/g
SiO_2	21.50	
Al_2O_3	4.77	Setting time: { initial: 116 minute final :150 minute (ASTMC191)
Fe_2O_3	3.97	
MgO	1.66	Compressive strength 28 days(ASTMC109):48 MPa
K_2O	0.69	
Na_2O	0.63	
SO_3	1.05	
L.O.I	1.81	Bogue's potential phase composition: $\text{C}_3\text{S}=44$ $\text{C}_2\text{S}=28$ $\text{C}_3\text{A}=5.92$ $\text{C}_4\text{AF}=12.08$
insoluble residual	1.9	

Table 2. Chemical and physical properties of mineral admixtures that used

properties		Indian metakaolin	Semnan silica fume	Yazd nanosilica
Chemical analysis (wt. %)	SiO ₂	50.9	89.22	>97.7
	Al ₂ O ₃	44.1	1.20	-
	CaO	0.4	1.87	-
	Fe ₂ O ₃	0.5	2.12	-
	TiO ₂	2.6	-	-
	MgO	-	1.61	-
	Na ₂ O	-	0.55	-
	K ₂ O	-	10.5	-
	L.O.I	2.2	2.60	2.3
physical properties	partical size (d ₅₀)	2 μm	0.3 μm	50 nm
	specific surface area (BET) m ² /g	15	24	200

in the north of Iran with specification summarized in table 1.

The metakaolin obtained from Indian Riddhi Enterprise Company, the silica fume from Iran Ferrosilica Company in the Semnan (Iran), nanosilica from Isatissilica company in the Yazd (Iran). The chemical composition and physical

properties of these materials are shown in table 2.

X-Ray diffraction (XRD) patterns of Indian metakaolin and Iranian nanosilica were shown in the Fig. 1. The phase analysis showed that nanosilica is amorphous and metakaolin have amorphous aluminosilicate and quartz phases.

Quartzitic sand and gravel were prepared

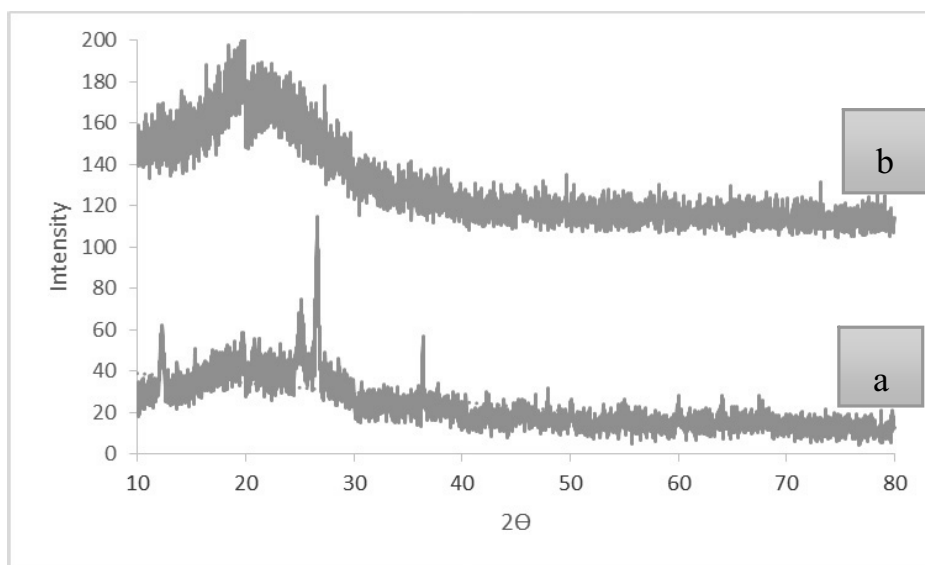

Fig. 1. X-ray analysis of (a) metakaolin, (b)nanosilica

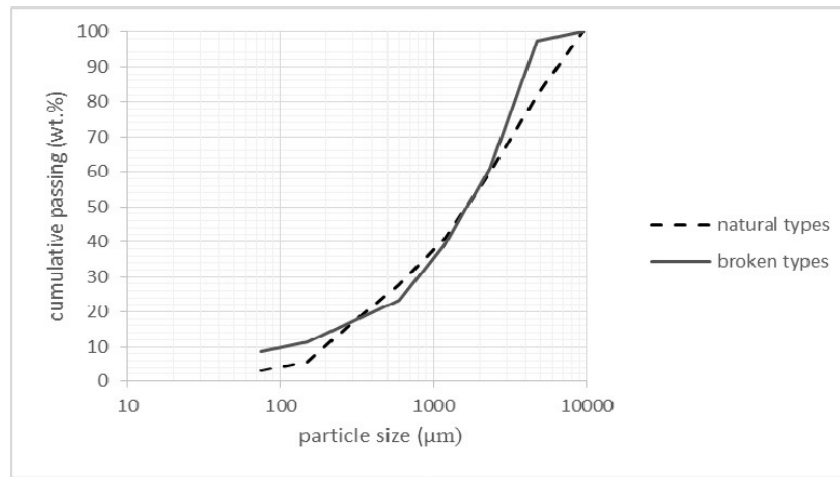

Fig. 2. Specification of natural and broken type aggregates

from Metosako Company (from mine near to Shahriar in near of Tehran). Two kinds of aggregates (natural spherical type and broken type with edge particles) were used in the concrete samples which their grade is shown in Fig. 2.

The water absorption of natural and broken aggregate were 3.1% and 3% , respectively, and specific gravity of those were 2.49 and 2.54 g/cm³, respectively.

A polycarboxylate aqueous solution admixture with specific gravity=1.1 g/cm³, pH=7 without Cl⁻ ions was used as a superplasticizer, that prepared from Chyso company with trade name Chyso-Optima 270. Polycarboxylate superplasticizer in a cement-water system acts as a water reduction and dispersant admixture with electrostatic repulsion and steric hindrance mechanism.

2. 2. Mix Proportions and Testing Methods

Grain size of sand, water cement ratio, proper mixing and curing are important to reach high strength concrete. According to Fig. 2, two sand types were used as aggregates. The natural sand have approximately spherical grains that improve filling density and broken sand with edge shaped grains that improve contact of aggregates. The proper ratio of aggregates obtained 60wt. %

broken and 40wt. % natural types with preliminary trials of natural and broken sands with different ratios, and then measurements of compressive strength of samples. Then, all concrete mixture were designed with base on water cement ratio 0.35 and cement content of 650 kg/m³ that were shown in table 3. Sample OPC is a reference type that in MK, SF and NS samples metakaolin, fume silica (microsilica) or nanosilica were substituted by Portland cement as 5-15wt% cement in MK and SF types and 0.8-5wt% cement in Ns types.

The amount of superplastic (SP) were adjusted to the amount that reaches to slump flow of 60-75 cm. As can be seen in table 3, with increasing the mineral admixtures, the amount of SP increase from 0.475wt% to 0.982, 0.842, and 1.60 wt% cement for 5wt% substitution metakaolin, silica fume and nanosilica, respectively that is related to surface area and particle shape of these admixtures.

The mortar mixtures were prepared using a tilting drum mixer. The interior of the drum was initially washed with water to prevent additional absorption of water. First, two types of sands (natural and broken) were mixed about one min, then Portland cement or premix portland cement+metakaolin or silica fume were added and mixed for one min followed by the addition of the water containing required amount of

Table 3. Concrete mixture proportions (kg)

mix type	water	cement	admixture			aggregates (40% natural+60% broken)	super plasticizer
			MK	SF	NS		
OPC	35	100	-	-	-	220.7	0.485
MK-5	35	95	5	-	-	220.7	0.982
MK-10	35	90	10	-	-	220.7	1.41
MK-15	35	85	15	-	-	220.7	1.59
SF-5	35	95	-	5	-	220.7	0.842
SF-10	35	90	-	10	-	220.7	1
SF-15	35	90	-	15	-	220.7	1.17
NS-0.8	35	99.2	-	-	0.8	220.7	1.15
NS-1.5	35	98.5	-	-	1.5	220.7	1.26
NS-3	35	97	-	-	3	220.7	1.37
NS-5	35	95	-	-	5	220.7	1.60

superplasticizer. The total mixing time was 7 min. In nanosilica containing samples, nanosilica and some of the water and plasticizer were premixed with stirrer (with speed of 120 rpm) and then added in final stage to drum mixer.

After determination of slump flow, immediately mortar cubes (1000cm³) were prepared as samples for compressive strength and electrical resistivity test. Additionally, slabs (150×100×90mm³) specimens were prepared for abrasion test with casting and compaction with small hammer (25 strokes) in three stages. Specimens were demolded at the age of 24h and cure at 25±3°C under lime containing water until testing. The mortar cubes were used for the measurements of compressive in accordance with DIN 1961 [15] with machine model CM111. Surface electrical resistivity is one of the corrosion durability of the concrete tests which was measured using two-electrical method for cubic samples [16]. Copper electrodes were placed in contact with concrete samples and after applying electrical current, voltage between two electrodes was measured and then from Eq.1, electrical resistivity (ρ) was determined [17].

$$\rho = V.A / I.L = R.A / L \quad (1)$$

The included parameters in this equation are as follow:

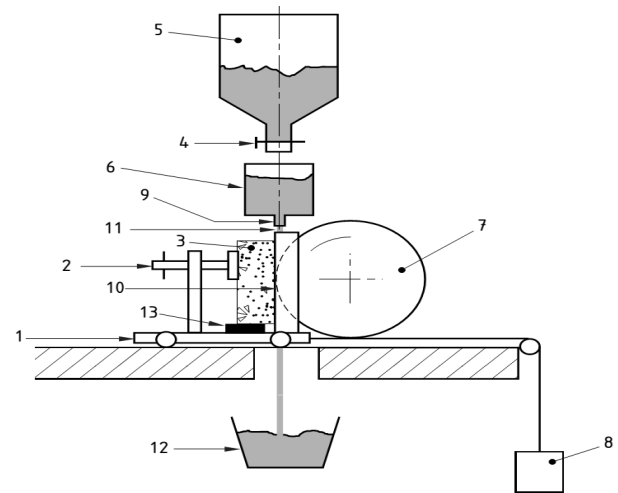

- Key**
- | | | |
|--------------------|------------------------|---------------------------|
| 1 Clamping trolley | 6 Flow guidance hopper | 11 Abrasive material flow |
| 2 Fixing screw | 7 Wide abrasion wheel | 12 Abrasive collector |
| 3 Specimen | 8 Counterweight | 13 Wedge |
| 4 Control valve | 9 Slot | |
| 5 Storage hopper | 10 Groove | |

Fig. 3. Abrasion testing machine [18]

V: voltage, A: cross section area of the specimen, I: current, L: length of the specimen, and R: electrical resistance.

Abrasion tests were done according to EN BS 1338 with testing machine similar to Fig. 3. After setting and fixing sample (3), the cast iron driving wheel attached the surface of samples and then alumina grinding powders (9) pass from distance between surfaces of samples and rotating wheel. Due to the abrasion, some grooves established on the surface of concrete specimen and the width of these grooves were measured and reported as a grinding resistance.

After milling, OPC, MK-15, FS-15 and NS-5 samples aged for 28 days, XRD analysis were carried out with a Philips device (PW1800) using Cu-K α radiation. The microstructure of the samples were recorded using a scanning electron microscope (SEM/EDS, TESCAN VEGAII).

3. RESULTS AND DISCUSSION

The value of compressive strength of the various mixtures at different aging time; 3, 7, and 28 days are shown in Fig. 4.

These strengths were determined from average

of three cubic specimens' value. The results showed that for aging 3 days after moulding of specimens, the compressive strength of metakaolin or silica fume containing concrete samples decreases about 4.1-5.3% and 4.6-8.7%, respectively regarding to the reference sample (OPC). Samples containing nanosilica aged for 3-days showed 6.5-19% increment in strength for 0.8-5wt% replacement to cement in comparison with the reference sample. In these samples, the maximum strength obtained at 1.5wt% replacement. All samples aged for at 7-days and 28-days with different amounts and types of metakaolin, fume silica or nanosilica showed considerable increment in compressive strength. Moreover, they showed 16% and 10% increment in compressive strength reading to the reference sample at 15wt% replacement of metakaolin and silica fume. For specimens containing nanosilica, maximum compressive strength was obtained by 0.8wt% substitution of nanosilica with increment of 26% in comparison with OPC sample. The maximum compressive strength of 28 days aged samples were 76.44 MPa and 79.48 MPa for 15wt. % substituted metakaolin and fume silica, respectively that showed 28 and 33% increment.

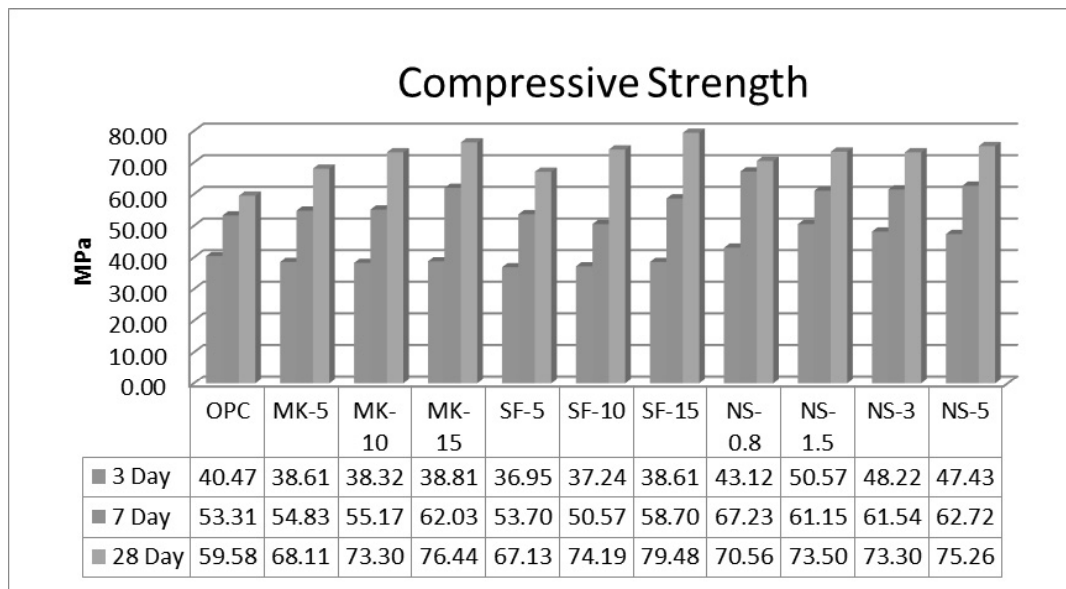

Fig. 4. Compressive strengths of different mortar samples aged for 3, 7, or 28 days with different substituted amount of of metakaolin (MK), fume silica (SF) and nanosilica (NS).

For nanosilica containing samples, maximum compressive strength were obtained for sample aged 28 days with 5wt% substitution and reaches to 75.26 MPa with 26% increment in comparison with OPC sample.

The trend of compressive strength changes in this study is similar to the results of other researchers [1, 9]. Sabir et al. [1] noted that pozzolanic reaction at Portland cement mortars containing metakaolin or fume silica reaches to the maximum level after 7-14 days aging and continue up to 90 days. Singh et al. [9] showed that in nanosilica containing pastes, due to high surface area of nanomaterials, intense pozzolanic reaction occurs after 24h from moulding. After 28 days aging they showed 20-25% increment in pozzolanic reaction with 0.5-2 wt% replacement of nanosilica. Moreover, they noted that at nanomaterial containing samples, specially with above 2wt% replacement, reduction in strength could be occurred. This behavior can be due to agglomeration and unsuitable dispersion of nanomaterials. Some compressive strength in nanosilica containing samples do not have logical trends due to possibility of inappropriate dispersion.

Mineral admixtures enhance the compressive strength of cement hardened paste by four mechanisms named; pozzolanic effect, packing effect, nucleation sites effect and improvement of interfacial transition zone [19]. In cement, metakaolin and water mixture, metakaolin ($\text{Al}_2\text{O}_3 \cdot 2\text{SiO}_2$) reacts with $\text{Ca}(\text{OH})_2$ and produces a cementing compound like C-S-H and alumina-containing phases including C_4AH_{13} , C_3AH_6 and C_2ASH_8 [13,14]. Calcium hydroxide (Portlandite) released from C_3S and C_2S phases in cement during the hydration in addition of C-S-H phases. The consumption of Portlandite and formation of new C-S-H phases (tobermorite similar phase) explain the improvement of both strength and durability of concrete.

In cement along with nanosilica or fume silica and water the following reactions could happen [9].

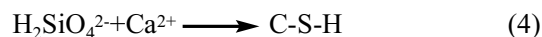
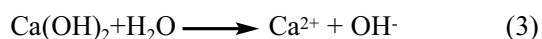

The packing effect of mineral admixtures is filling interstitial spaces inside the microstructure (filler effect), which increases density and strength with decreasing the amount and size of porosities. In metakaolin containing mortar cured for 28-days, the average pore diameter and total porosity amount decrease from $0.034\mu\text{m}$ and 16.58vol. % for metakaolin free sample to $0.018\mu\text{m}$ and 13.38 vol. % for metakaolin substituted sample [14]. The increase in the strength of concretes containing mineral admixtures in addition of the filling and pozzolanic effects can be attributed to the improvement of sand-matrix bond due to better interlock between paste and sand [20].

The pozzolanic reactivity of mineral admixtures depends on their surface area, crystallinity, distribution homogeneity in the matrix, water/cement ratio, amount of replacement and curing conditions of mortar samples. As shown in Fig. 4, in metakaolin and silica fume containing samples aged for 3 days, strength were decreased while for nanosilica containing samples were increased. All samples with mineral admixtures aged for 7-days and 28-daysshowed higher strength in comparison with the OPC sample. The increment of strength as mentioned before is related to three mechanism named; filling effect, pozzolanic reaction and improvement of interfacial bond, however, for decreasing strength of 3-days aged MK and SF samples, other mechanisms can be contributed.

It is declared that at lower water/cement ratios such as this study, due to the surrounding of cement particles by silica fume or other mineral admixtures, the amount of water at contact area of cement particles decrease. As a result of this, the initial period of hardening of cement probably delayed [21]. It seems that in this study the above reason controlled the strength of 3-days aged MK and SF samples.

Figure 5 shows backscattered electron (BSE) images of the samples containing sands (S) and matrix (M). Matrix contains hydrated cement phase and unreacted cement (R) for OPC sample while for SF sample after curing for 28 days, it contains mentioned phases plus silica fume and

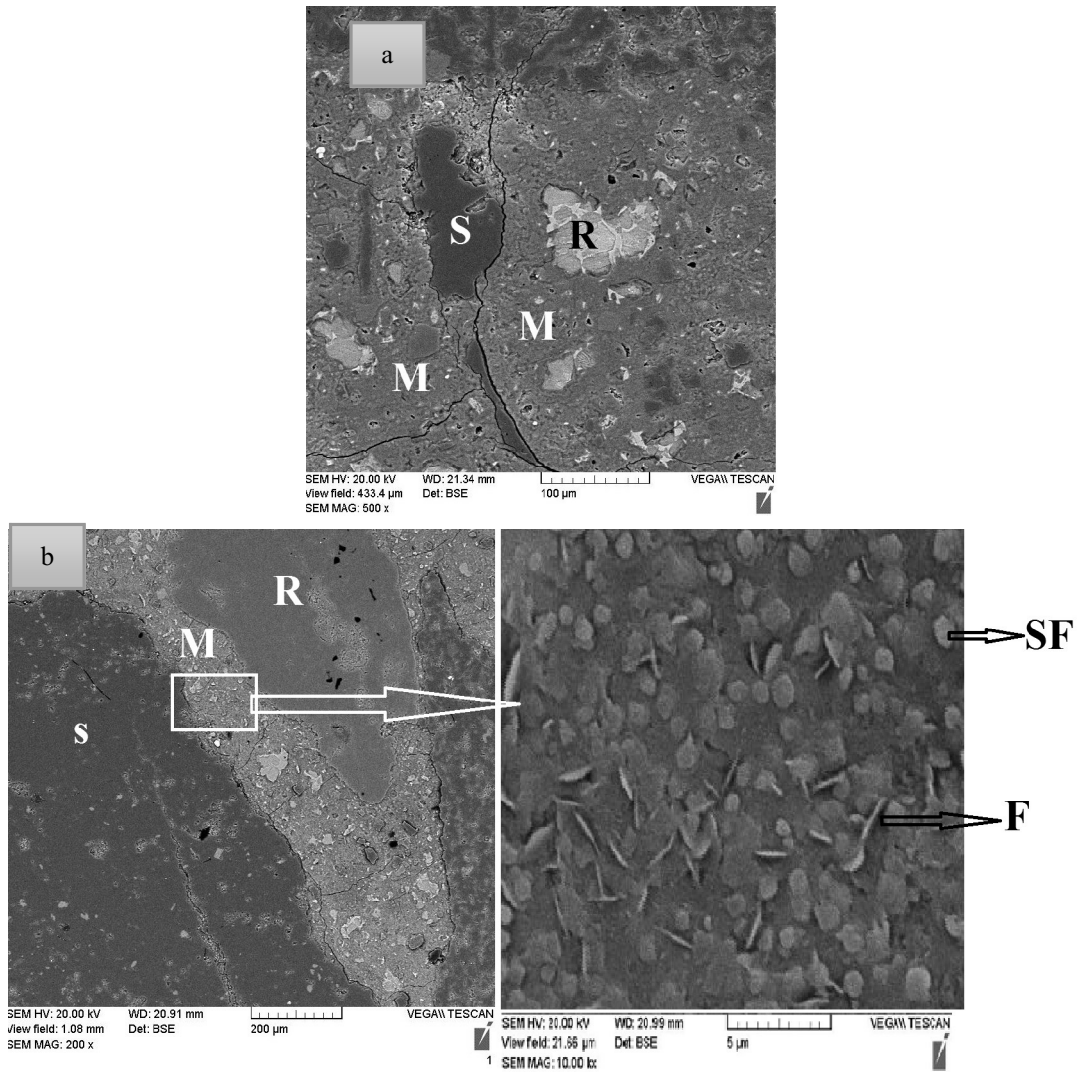

Fig. 5. SEM of a) OPC and b) SF-15 samples after 28 days curing

new C-S-H gel. It shows that matrix in the SF sample was improved and fiber C-S-H similar phases (F) are distributed near silica fume (SF) particles.

XRD patterns of OPC and SF-15 samples after 28-days curing were shown at Fig6. As shown in these samples, Alite (CS), hydrated calcium silicate (CSH), Portlandite ($\text{Ca}(\text{OH})_2$) and ettringite (e) phases present that Portlandite decrease in SF-15 sample due to pozzolanic reaction.

Figure 6 shows the electrical resistivity of

different mixtures cured for 28 days and relative humidity of 48%. The results indicate higher electrical resistivity of cement mortars containing all studied replacement level of metakaolin, silica fume and nanosilica in comparison with OPC reference sample. These higher electrical resistivities are due to the formation of new C-S-H phase from pozzolanic reaction and decrease of pore size, total pore amount and ionic content of water in pore. The electrical resistivity of SF-15, MK-15 and MS-5 samples were 21 $\text{k}\Omega\cdot\text{cm}$, 15 $\text{k}\Omega\cdot\text{cm}$ and 8.9 $\text{k}\Omega\cdot\text{cm}$, respectively, which

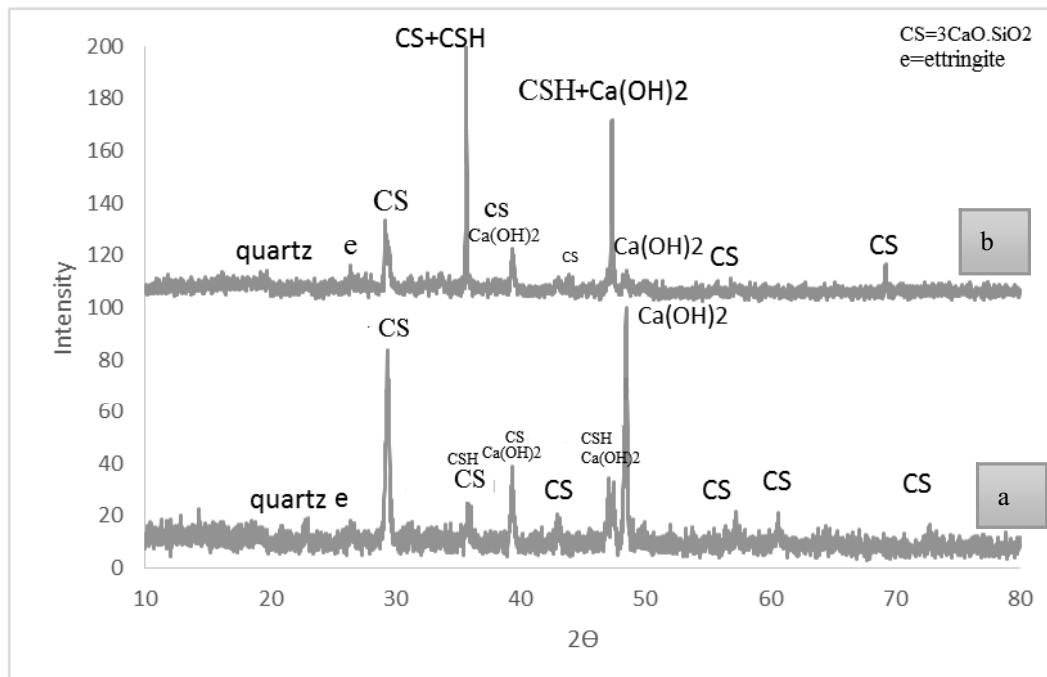

Fig. 6. XRD patterns of a) OPC b) SF-15 samples after 28-days curing.

showed 526%, 347% and 219% increment to the reference sample resistivity (3.35 kΩ.cm), respectively. Electrical resistivity demonstrates that high durability of cement containing materials. Total porosity, pore size distribution, chemical composition of liquid phase in pores of hardened cement paste and relative humidity of surrounding atmosphere of sample control the amount of resistivity [8]. The amount of electrical resistivity of solid phase at cement paste are over 103k that declared solid phase acts as an insulator but with present of water containing ionic elements at pores, resistivity decrease. Some of these parameters are included in the following equation [22].

$$\rho_c = P/\sigma_0.P_0(p-p_c)^\gamma \quad (5)$$

In this equation, ρ_c is the resistivity of cement based materials, P is volume fraction of pore solution, P_c is the critical volume fraction (percolation threshold), γ is the critical exponent, σ_0 is the conductivity of the pore solution in a sample exposed to 98.5% relative humidity, P_0 is the volume fraction of pore solution at the same

conditions. Percolation threshold showed the transition between conducting and insulating behavior of the material and was taken as volume percent of total porosity that must be filled with solution for starting of conductivity. With addition of mineral admixtures such as metakaolin, silica fume and nanosilica, (P- P_c) and σ_0 decreased thus ρ_c increased.

In electrical resistivity and corrosion resistance of cement mortar, the disconnection of water containing capillary porosities are more important than the total porosity including open, capillary and air entrapped porosities[23, 24]. Therefore, with increasing of supplementary mineral addition, due to filling effect and formation of new C-S-H phase, the connection of capillary pores network decreases and as a result, electrical resistivity increases. The amount of capillary pores for water to cement ratio of 0.4 reaches to approximately 11 vol. % of the paste [24].

Figure 8 shows width of groove that established from action of abrasion wheel along with grinding powders for OPC, MK-15, SF-15 and NS-5 after 28-days curing. The results showed that silica fume containing sample (SF-

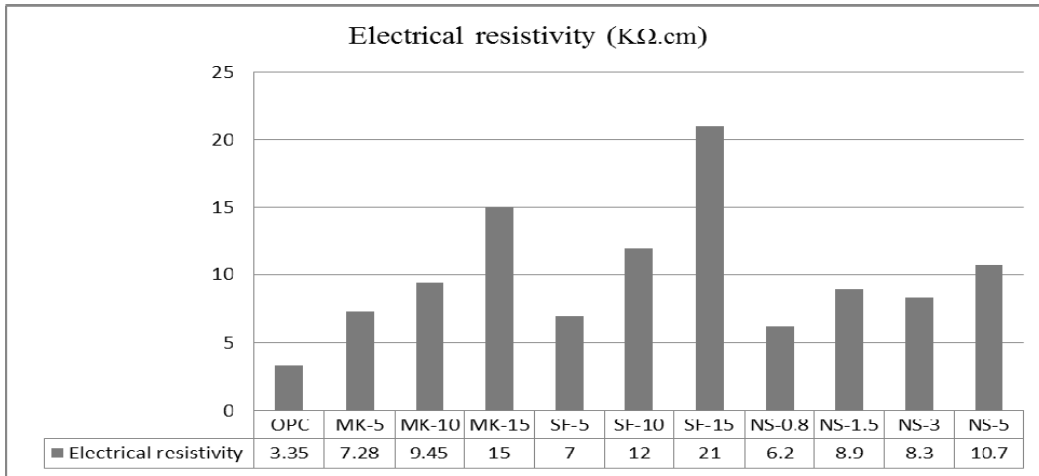

Fig. 7. electrical resistivity of different mixes after 28-days and relative humidity=48%

15) have the maximum abrasion resistance and metakaolin (MK-15), nanosilica containing samples have better abrasion resistance to the reference sample (OPC). The abrasion resistance relates to the total porosity, size of porosity, hardness of different constituents and microstructure of cement mortar. Different correlation was found between Rockwell hardness of cement pastes and logarithmic terms of compressive strength [25]. The SF-15 had the

highest value of compressive strength to other studied samples and also unreacted silica fume at matrix of samples have higher hardness from unreacted metakaolin at matrix.

Figure 8 shows that nanosilica containing sample (NS-5) have lower abrasion resistance than silica fume (SF-15) sample. It seems that due to the unsuitable dispersion of nano material at mortar sample, the low adhesion zone was formed which is responsible for this trend similar

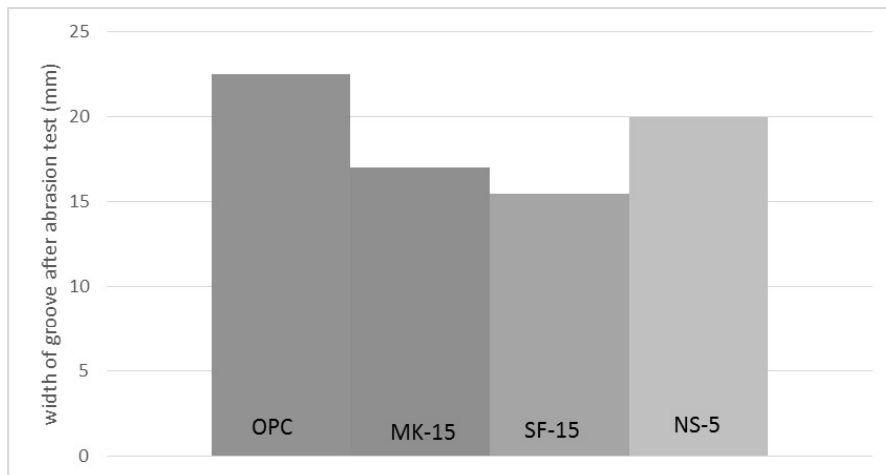

Fig. 8. Width of groove (abrasion resistance) of different samples after 28-days curing

to strength trend of this sample.

4. CONCLUSIONS

Based on the experimental studies presented in this paper, the following conclusions can be drawn:

1. Addition of mineral admixtures to cement mortars and curing for 28 days result in increment of the compressive strength to 76.44MPa, 79.48MPa and 75.26MPa for samples containing 15wt.% substitution metakaolin or micrisilica and 5wt.% substitution nanosilica.
2. The X-ray diffraction pattern of silica fume containing samples shows decreasing in Ca(OH)₂ content due to pozzolanic reaction.
3. The microstructure of silica fume containing sample shows better bond between sand and matrix, with new C-S-H phases near unreacted silica fume.
4. The electrical resistivity of silica fume containing sample reaches to 21 kΩ.cm after aging for 28 days in relative humidity of 48% which shows increment of 526% relative to the sample without additive.
5. The abrasion resistance of mortar increases with the addition of metakaolin, silica fume and nanosilica while 15wt. % silica fume containing sample have maximum abrasion resistance.

REFERENCES

1. Sabir, B. B., Wild, S. and Bai, J., "Metakaolin and calcined clays as pozzolans for concrete,a review" cement & concrete composites, 23, 2001, 441-454.
2. Saunders, A., "Top 75 producers of cement", global cement magazine 9, 9,8-16,2013, 8-16.
3. Ohunakin, O. S., Leramo, O. R., Abidakun, O. A., Adunfa, M. K. and Bafuwa, D. B., "Energy and cost analysis of cement production using the wet and dry processes in Nigeria" Eney and Powe engineering 5, 2013, 537-550.
4. Hassan, K. E., Cabrera, J. G. and Maliehe, R. S., "The effect of mineral admixtures on the properties of high-performance concrete" Cement & Concrete Composites 22, 2000, 267-

- 271.
5. Hewlett, P. C., "The role of admixtures in concrete materials "Engineering applications 1, 1979, 335-342.
6. Usharov-Marshak, A. V., Zlatkovskii, O. A. and Ciak, M., "Assessing the efficiency of chemical and mineral admixtures in early cement hydration" Inorganic Materials, 40 [7], 2004, 886-890
7. Shannag, M. J., "High strength concrete containing natural pozzolan and silica fume" cement & concrete composites, 22, 2000, 399-406.
8. Zahedi, M., Ramezaniapour, A. A. and Ramezaniapour, A. M., "Evaluation of the the mechanical properties and durability of cement mortars containing nanosilica and rice husk ash under chloride ion penetration" Construction and Building Materials 78, 2015, 354-361.
9. Singh, L. P., Karade, S. R., Bhattacharyya, S. K., Yousuf, M. M. and Ahalawat, S., " Beneficial role of nanosilica in cement based materials-A review" Construction and building materials 47, 2013, 1069-1077.
10. Garcia-Taenhua, E., Sonebi, M., Hossani, K. M. A., M., Lachemi and J., Khatib "Effects of the addition of nanosilica on the rheology,hydration and development of the compressive strength of cement mortars " composites port B 81, 2015, 120-129.
11. SabdonoSabdono, P., Sustiwawan, F. and Fadiilah, D. A., "The Effect of nano-cement content to the compressive strength of mortar" procedia engineering 95, 2014, 386-395.
12. Souri, A., Kazemi-Kamyab, H., Snellings, R., Naghizadeh, R., Golestani-Fard, F. and Scrivener, K., "Cement and Concrete Research" 77, 2015, 47-59.
13. Souri, A., Golestani-Fard, F., Naghizadeh, R. and Veise, S., "An investigation of pozzolanic activity of Iranian Kaolin obtained by thermal treatment" Applied Clay Scince, 103, 2015, 34-39.
14. Singh, M. and Georg, M., "Reactive pozzolan from Indian clays-their use in cement mortars" cement and concrete research 36, 2006, 1903-1907.
15. DIN EN 196-5, "Methods of testing cement - Part 5: Pozzolanicity test for pozzolanic cement; German version EN 196-5:, 2011

16. Tamas, F. D., "Electrical conductivity of cement paste" cement and concrete research 12, 1982, 115-120.
17. Fiho, J. H., Medeiros, M. H. F., Pereira, E., Helene, P., Asce, M. and Isaia, G. C., " High volume fly ash concrete with and without hydration lime; chloride diffusion coefficient from accelerated test " Journal of material in civil engineering, 25, 2013, 411-418.
18. EN BS 1338 : 2003 "Concrete pavingblocks - Requirements and test methods" " EN BS 1338, 2003.
19. Al-Mishhadani, S. A., Ibrahim, A. M. and Naji, Z. H., "The effect Effect of nano Nano metakaolin Metakaolin on some properties of concrete" Diyala Journal of engineering science, 6, 2013, 50-61.
20. Shannoy, M. J., "High strength concrete containing natural pozzolan and silica fume "cement and concrete composites 22, 2000, 399-406.
21. Lanngan, B. W., Weng, K. and Award, M., " Effect of silica fume anf fly ash on heat of hydration of Portland cement" Cement and concrete research 32, 2002,1045-1051.
22. Buerchler, D., Elsener, B. and Boechni, H., "Electrical resistivity and dielectric propreties of hardened cement paste and mortar" Mat. Res. Soc. Symp. Proc vol. 411, 1996, 407-412.
23. Shimamura, S. and Tashiro, C., "Contribution of evaporable water to electrical conduction in porous hardened cements " Journal of materials science letters 11, 396-398, 1992.
24. Kumar Mehta, P. and Monteiro, D. J. M., "concrete microstructure, properties and materials", third edition Macc Graw-Hill, 2006.
25. Winslow, D. M., " A Rockwell hardness test for Portland cement concrete" research project, School of civil engineering purdue university, Indiance, 1981.