

OPTIMUM FORM AND PLACEMENT OF URBAN BLOCKS TO MAXIMIZE THE USE OF SOLAR ENERGY – A CASE STUDY

A. Aali¹, F. Haghparast¹, A. Maleki^{1*†}, A. Shakibamanesh² and P. Ghobadi¹

¹*Department of Architecture and Urban Planning, Tabriz Islamic Art University, Tabriz, EA, Iran*

²*Department of Architecture and Urban Planning, Tehran University of Art, Tehran, Iran*

ABSTRACT

Growing tendency for Urbanization and rapid development of the cities has resulted in urban neighborhoods obstructing the access of each other to the natural sources e.g. solar energy, natural ventilation. Sunlight as the main part of input energy in urban energy balance equation and natural lighting is of vital importance. This paper attempts to achieve an optimum morphology for residential blocks in urban area with the highest exposure to the sunlight. To reach this goal a pilot area in Tabriz's downtown was selected and regarding solar angle, local street regulations and the width of surrounding streets 3 different scenarios for the buildings blocks were defined. Using a three-dimensional microclimate model, ENVI-met, solar access of defined scenarios was calculated for the longest and the shortest day of the year. Results showed that Type C2 (highest, more open spaces) is a more efficient style for winter times as it receives more of the sun's energy and also the amount of sun it gets during a day and type B2 (medium open space and height) is the better for summer as it gets less energy from the sun and it is exposed to sunlight less than other types in a hot summer day.

Keywords: optimum morphology; solar energy; residential neighborhood; simulation; ENVI-met; Tabriz.

Received: 10 January 2017; Accepted: 18 April 2017

1. INTRODUCTION

Throughout history, man has often modified his climatic environment. Urbanization has brought about the most radical changes. Modern cities have developed with little or no regard for the climatic modifications created. The city has an infinite number of

*Corresponding author: Department of Architecture and Urban Planning, Tabriz Islamic Art University, Tabriz, EA, Iran

†E-mail address: a.maleki@tabriziau.ac.ir (A. Maleki)

microclimates intimately linked to the composition of its surfaces and the relationships of its structures. This urban-atmospheric system is interdependent, and climate cannot be treated independently of the city. Microclimates created or destroyed by the shade effect of tall buildings are a simple example.

An understanding of the microclimates created by buildings should aid in the planning of new towns or the redevelopment of old ones. Design and layout can often turn microclimatic liabilities into assets. The collaboration of climatologists with architects and planners is needed to achieve a better result.

The information gap between urban designers, architects and climatologist has not been bridged by traditional approaches in climatology. Air temperature and humidity data on the standard screen height of weather shelters fail to measure the most significant phenomena of energy, mass, and momentum exchanges at the interface. A predictive methodology is needed to deal with the fundamental processes of the varied geometries and compositions of the city's fabric. Only an energy budget approach will untangle the complex web of microclimates in urban areas.

Solar radiation as a major input of urban energy balance, should be considered early in the building design. The solar input should influence decisions as to building orientation, height, density, acceptable glass cover, and heating and air-conditioning requirements. Solar radiation is also a major factor in the climate comfort of the urban residents. The differential heating of the urban complex and its environs is partially responsible for the creation of the urban heat island and the associated convection cells, with considerable consequences for air pollution.

In attempting an analytical approach to models in urban climatology, it appears best to examine first input-output characteristics by simulating 3 figurative urban blocks which can be placed at any location on this planet, and can be subjected to sensitivity analyses of the influence of interface geometry and orientation on shortwave energy fluxes. How does the city's mere physical structure, modify the solar energy budget?

Buildings account for approximately 40% of global energy consumption and play an important role in the energy market. Building sustainable design principles, in addition to being comfortable and meeting the needs of residents, a special effort must be taken to reduce the environmental impact of buildings. These principles are based on the following factors: energy efficiency, solar access, indoor air quality, water systems, construction materials [1]. Buildings' energy demand is predicted to continue growing worldwide in the coming decades [2][3]. In addition, the building sector has a significant influence on natural resource utilization [4]. Hence, while buildings provide facilities for human needs and their countless benefits to the society cannot be ignored, buildings have also had destructive influences on the environment during last decades [5].

Since forty years ago, the energy demand from buildings (including residential and commercial buildings) has grown by 1.8% per year and it is predicted to grow from 2790 Mtoe (116.8 EJ) in 2010 to over 4400 Mtoe (184.2 EJ) by 2050, with most of this increase being from developing countries [6][7]. Three-quarters of total energy consumption in the building sector is residential, where there is great potential to improve energy efficiency [8]. Fig. 1 demonstrates the percentage of total consumption that is residential in different regions of the world, which fluctuates from an average of 20% in the developed countries to more than 35% in the developing countries [9] (Fig. 2). Residential energy demand is prominent both for its present size and potential growth [10].

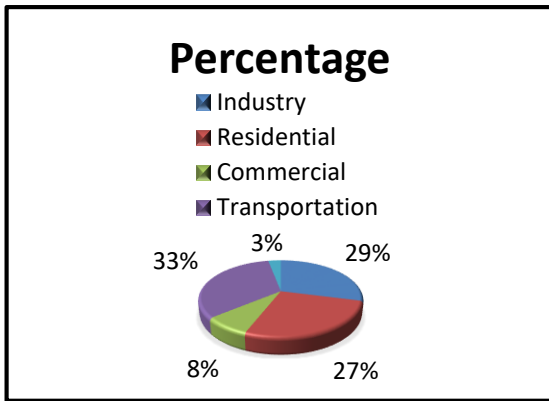

Figure 1. Percentage of total consumption (Adapted from [8])

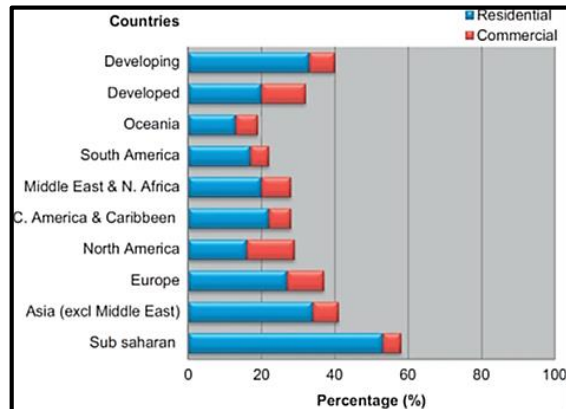

Figure 2. residential and commercial energy demand in the world [8]

In addition, buildings are also responsible for one-third of global energy-related global greenhouse gas (GHG) emissions [11]. Carbon dioxide (CO₂) emissions are believed to account for approximately three-quarters of GHG emissions, and CO₂ is seen as the main gas responsible for climate change [12]. According to the above, the residential sector can play a pivotal role in decreasing global total energy-related CO emissions. Ten countries, including the United States, China, India, Russia, Japan, Germany, South Korea, Canada, Iran, and the United Kingdom constitute the world’s major GHG emitters. Their emissions account for nearly two-thirds of total emissions (Fig. 3Figure), which proves their considerable and direct effects on world energy expenditure and the global environment [13].

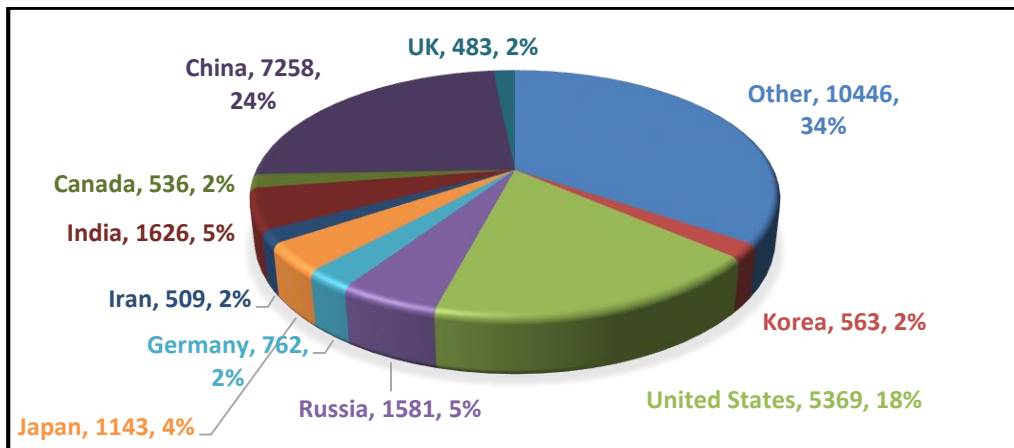

Figure 3. global greenhouse gas (GHG) emissions (Adapted from [13])

The morphology of a city can be conveniently generalized by certain dimensions of buildings and streets: building height h , building depth w , and widths between buildings across the street d . The ratio of the distance between adjacent buildings to street width d is small enough to be considered insignificant in densely built-up areas [14]. This paper assumes that, by using sun light and solar energy and finding a better positioning and

placement of urban blocks sustainable urban design processes can be partly achieved. Thus to reach sustainable city, this article aims to understand how much can solar energy effect a building in different scenarios and finding the best method to reach optimum height for an urban block in the city of Tabriz. By conducting different simulation with different enacted scenarios, block placements and block sizes, optimal shape and placement was achieved. Because the results in different cities are case specific and geographical and environmental condition and enforced regulation differ, it is better that examinations be done separately for each city. Although in Iran some small strategies have been implemented in transport and traffic section but sustainable urban design has been neglected [15]. With this aim in mind, we have chosen Tabriz as our case study area. The city is growing and is the fourth largest city, well known for its distinct urban structure and applied policies. Due to the growing concern for environmentally and climatologically friendly urban design and sustainable development, new regulations are much needed in this context.

2. LITERATURE REVIEW

In the present context of society dependence on energy, a more sustainable model of urban planning is required, one that is able to provide different solutions for urban development taking into account the solar energy potential. Jouri Kanters and Miljana Horvat did a study on “Solar energy as a design parameter in urban planning”. This study shows an exploration of geometrical forms of urban blocks and the potential of solar energy to the local production of energy. Simulations were performed in 2012 with the program Ecotect for the city of Lund in southern Sweden. It was found that the impact of the geometry form on the potential of solar energy was significant (up to twice as much) and some forms were found to be less sensitive for different orientations. When the urban blocks were surrounded by other geometry, which resembles the situation of a dense city, the contribution of solar energy decreased by 10-75% [16].

In a research about “Typical Values for Active Solar Energy in Urban Planning” the annual solar energy potential of typical Swedish city blocks was analyzed in order to develop guidelines for urban planners and architects. The results show that the design of the city blocks has a significant effect (up to 50%) on the total annual solar energy production. The study done by Jouri Kanters, Maria Walla and Marie-Claude Dubois shows that the contribution from active solar energy can be significant even in the urban environment, but shading by adjacent buildings may greatly limit the total amount of energy produced [17].

In 2016 effects of the variation of physical and geometrical properties of the urban fabric (i.e. cool roofs including green and white roofs and perviousness of paving materials) on the urban microclimate and outdoor thermal comfort were investigated using 3dimensional urban microclimate model, ENVI-met. Based on the predicted results, increasing the amount of vegetation and permeable pavements can cool the air temperature down by up to 3 K [18].

In a study done for the purpose of calibration and validation of the results of ENVI-met tool, Aida Maleki et al. illustrate the basic processes of calibrating and preparing a numerical model for the simulation of the urban microclimate [19].

3. RESEARCH METHODOLOGY

Several scenarios are based on surrounding streets, local building regulations, and solar angles for Tabriz, so it was determined that an optimum scenario regarding better solar exposure had to be found. This project required to simulate the conditions on the ground so computer simulation by means of ENVI-met was used.

3.1 Location

Tabriz has a continental climate with dry hot summers. The city is located in north western Iran and in the mountainous region with a cold and dry climate which has cold winters and temperate summers. Over the course of a year, the temperature in this city typically varies from -5°C to 34°C and is rarely below -11°C or above 37°C . The *warm season* lasts from June 1 to September 19 with an average daily high temperature above 28°C . The hottest day of the year is August 6, with an average high of 34°C and low of 22°C .

The *cold season* lasts from November 25 to February 27 with an average daily high temperature below 9°C . The coldest day of the year is January 20, with an average low of -5°C and high of 3°C (Fig. 4).

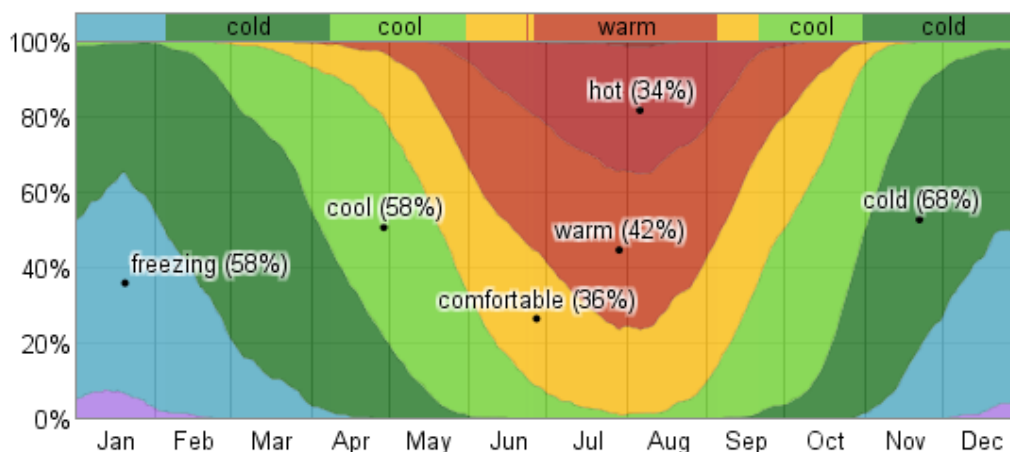

Figure 4. The average fraction of time spent in various temperature bands: frigid (below -9°C), freezing (-9°C to 0°C), cold (0°C to 10°C), cool (10°C to 18°C), comfortable (18°C to 24°C), warm (24°C to 29°C), hot (29°C to 38°C) and sweltering (above 38°C) [20]

The length of the day varies significantly over the course of the year. The shortest day is December 21 with 9:31 hours of daylight; the longest day is June 21 with 14:48 hours of daylight (Fig. 5) [21,22].

Solar access is favored in cold cities like Tabriz. East-west oriented street canyons do not have solar access during winter months due to the low zenith angle of the sun. However, during summer, the street canyon and especially the northern façade is illuminated during the whole day. Accordingly, the frequency of heat stress in this E-W oriented street canyon is high. A N-S oriented street canyon is accessed by sunshine during the mid-day hours throughout the year [23] [24].

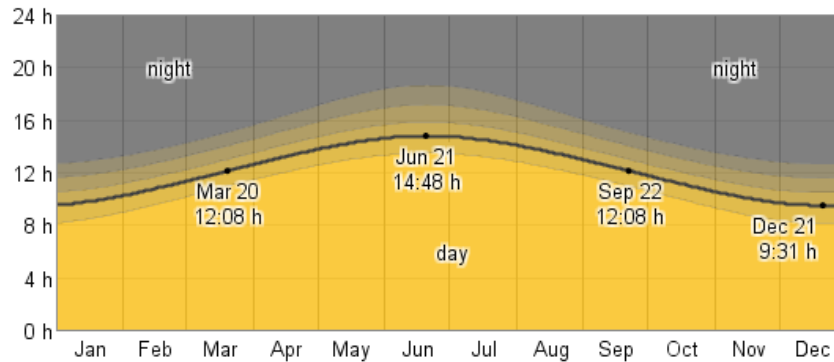

Figure 5. The number of hours during which the Sun is visible (black line), with various degrees of daylight, twilight, and night, indicated by the color bands. From bottom (most yellow) to top (most gray): full daylight, solar twilight (Sun is visible but less than 6° from the horizon), civil twilight (Sun is not visible but is less than 6° below the horizon), nautical twilight (Sun is between 6° and 12° below the horizon), astronomical twilight (Sun is between 12° and 18° below the horizon), and full night [20]

3.2 Scenarios

In this paper 3 types of residential blocks and effects of building positioning on total solar energy received in each block was investigated. Therefore, a pilot site located in $38^\circ 3'27.97''N$ and $46^\circ 17'59.79''E$ in the 3rd district of Tabriz, Iran surrounded by 4 streets [Azadi St. (20m width) - Artesh St. (18m) – Pastor St. (12m) – Hafez St. (12m)] was selected (Fig. 6 **Error! Reference source not found.**). it was used to be a military base that is moving to outside of the city and will be replaced with a residential neighborhood. The pilot site is 156816 m^2 (396×396) area from this site. The aim of the scenarios was to have all kinds of lights and shadow on buildings so a 3 by 3 block pattern was chosen. With this pattern, buildings have enclosure from 2 side to all 4 sides and there are buildings which wind directly hits them or moves through them. The distance between these blocks was calculated regarding solar angles (Fig. 7), local street regulations and the width of the 4 streets surrounding our figurative site in which this study takes place. The pilot size is a foursquare shape measuring $396 \times 396 \text{ m}^2$. (Fig. 8).



Figure 1. Location chosen for the pilot site

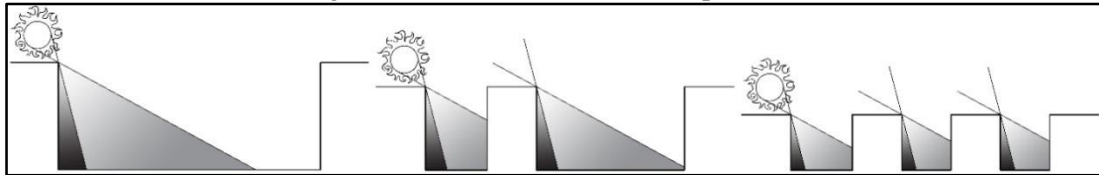

Figure 2. Solar angles and solar envelope and solar limits between winter and summer solstice for Type A(right) – B(middle) – C(left)

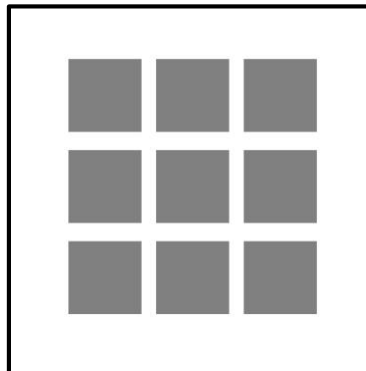

Figure 8. Pilot site and unit pattern

Each one of these 9 units was proposed in 3 types of smaller blocks (Fig. 9, Fig. 10). Distance between and density of these types was calculated according to surrounding streets and local building regulations and solar angles (Table 2, Fig. 7). We also chose these patterns according to Tabriz City Comprehensive Plan and stretched them from east to west so that the building in each block can get the south/north sun light according to solar angles. It is also worthy to mention that Tabriz is in the northern hemisphere and sun light from south is predominant.



Figure 3. A whole block is 3 types of smaller blocks in each scenario (Zoomed)

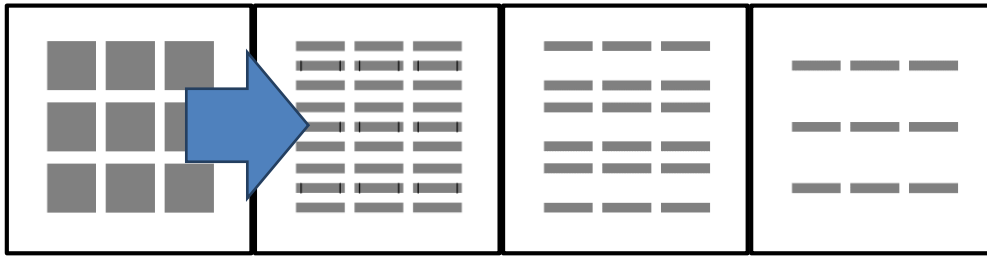

Figure 10. A whole block is 3 types of smaller blocks in each scenario

Every smaller block type was designed with its own different density. Density and building height was suggested by the city comparative and comprehensive plan according to the aspect ratio (building height / street width) and also analyzed using solar angles data gathered from Table 1 and Fig. 7 (Fig. 11).

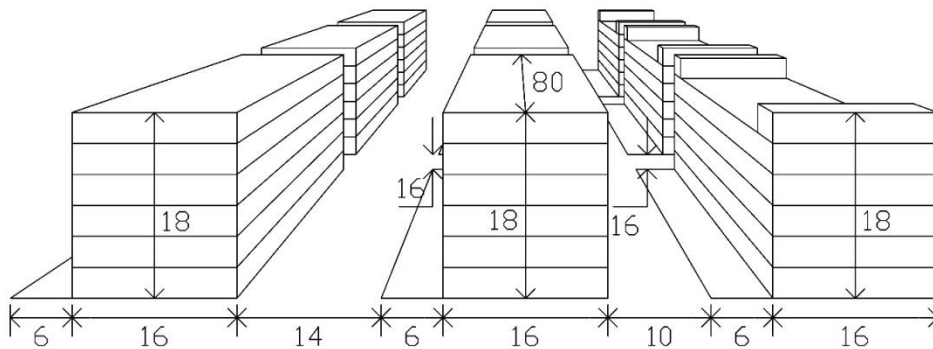

Figure 4. According to the aspect ratio (building height / street width)

3.3 Simulation tool

There are many alternatives for computer modeling and simulation tools proposed by scholars and researchers to evaluate the performance of urban design. Some computer softwares are very efficient but not good enough for any other purposes that do not meet the criteria and parameters used in the study. In this case, we categorize the computer modeling and simulation tools to assess the sustainability of urban morphology and analyze solar access. There are variety of tools that could be used by urban planners and designers for parametric assessment. In specific, urban form and solar access are among these parameters. Each of the computer programs is built with their parameters and characteristics. According to their functions, some of them are investigated as follows (Tabel 1).

Table 1: The List of simulations tools for Assessing Urban Morphology and solar access

Computer Software	Assessment Type	Development Scale
Ecotect Analysis	Thermal and energy analysis and solar access	Buildings and groups of buildings
IES VE-Pro	Building energy performance simulation	Buildings
Project Vasari	Wind tunnel analysis and energy consumption simulation.	Urban area
STEVE software	Estate Environment Evaluation	Urban area

DIVA and Rhino Grasshopper	Thermal, daylight, solar radiation, and glare simulation	Urban area
Computational Fluids Dynamic Analysis	Wind simulation	Urban area
City Engine	Modeling urban area and infrastructure	Urban area
Geographical Information System (GIS)	Modeling, visualize and analyzing spatial data	Urban area
Digital Evaluation Models (DEMs)	Digital model to analyze the effects of urban surface on building energy consumption	Urban area
Pareto Software	Analyzing the optimization of land use distribution	Urban area
EnergyPlus Software	Simulating the energy program	Buildings and groups of buildings
ENVI-met	Three dimensional microclimate model	Urban area
Urbawind	Three dimensional wind and thermal simulation	Urban area

(Source: Adapted from [25][26])

As this study focuses on the urban microclimate consideration on urban form performance, the feasible softwares that are suitable to meet the objective of the study are Project Vasari, STEVE, and ENVI-met. Those softwares are designed with urban microclimate parameters with respect to the urban design or urban form performance. The study justifies that ENVI-met software has more parameters to perform the urban microclimate assessment such as urban surface, humidity, wind flow, outdoor temperature, and other climate features. Furthermore, it also results the better resolution of shortwave radiation and solar access. By performing the structured comparison, we concluded that ENVI-met is suitable software in meeting this study's objectives. In the same manner, due to the considerations highlighted earlier and the scope of the study, ENVI-met is chosen to be the suitable computer model to perform the urban form assessment by using the urban microclimatic parameters.

This software is a 3D-model of a microclimate that is programmed to simulate the relationship between surface, vegetation and air in an urban environment with a precision rate from 0.5 to 10 meters in 10 seconds [27]. This CFD program is used to simulate microclimates and model air quality. Its application is in urban climate, architecture, building design, environmental planning and urban design. This model includes the simulation of flow around and between buildings, the process of heat and moisture in the surface and walls, disturbance, vegetation parameters, bioclimatology, dispersion of the particles and pollutants. In addition to this structural configuration, some basic design characteristics of ENVI-met as a simulation program includes;

- Simulate the complete coupled climate system including fluid mechanics, thermodynamics, pollutant dispersion;
- Provided a high resolution model resolving single buildings;
- Adequate simulation of surface-vegetation-atmosphere processes such as photosynthesis rate;
- Use of state of the art computational techniques;

- Easy to use interface and input/output data handling [27].

Input and output data: Climatic data like Wind speed at 10m above ground, the geographical coordinates and based points, wind direction, base temperature, humidity at 2,500 meters and relative humidity at 2m above ground, topography, soil type, soil temperature and levels, plant type, height, leaves and roots density, as well as points, lines and levels of greenhouse gases can be used as input data in this software. In contrast, outputs are in the form of numerical and statistical computations and graphical visualizations. These outputs contain all of the climatic parameters in the requested time frame. Gas concentration, wind speed, temperature and humidity are among them.

Input data required to initiate ENVI-met simulations are:

- Wind speed and direction at 10 m above ground level;
- Roughness length (Z_0);
- Initial temperature of atmosphere;
- Specific humidity at 2500 m;
- Relative humidity at 2 m.

Limitations: this software in its current state is designed for windows platform and does not work with other operating systems. One of its shortcoming is that its unable to use the full potential of threaded processors and also its 32bit architecture limits the amount of ram to 4GB that can be consumed by the program, as a result the maximum simulation size is limited to at most 1562500 cubical grids. Another problem with this application is that it will not use your Graphics Processing Unit for processing and simulation and it will only use 1 thread of you processing power.

Another limitation of the program is about the position of windows on the building facade. The basic version doesn't support it and even the pro version has a lot of problems and doesn't work correctly.

Strength and capabilities: Perhaps the most distinctive feature of this software with other software is that it seeks to reproduce the main process in the atmosphere that influenced the microclimate. Its benefits can be classified as such:

- 1- This application provides microclimate dynamic simulation on a daily cycle. The model is constant and non-hydrostatic and all processes in climate exchange, including wind flow, turbulence, radiation flux, temperature and humidity have been taken into consideration.
- 2- Accurate display of the city's complex structures is possible. Buildings with shapes, heights and different non-geometric designs, plants as porous barriers to wind and radiation and evaporation and transpiration have been considered and different types of vegetation and soil in the application are available.
- 3- High spatial resolution (up to 0.5 meters horizontally) and high accuracy up to 10 seconds to give an accurate reading of climate change through urban geometry.
- 4- It requires a limited number of numerical import but it has a wide range of numerical outputs.

One of the main fields of application of a microclimate simulation like ENVI-met is the analysis of the influence of buildings on the urban microclimate (e.g. [28]). The size and shape of buildings influences the wind flow and solar access within the streets and thereby greatly influence human thermal comfort on street level [29].

But the interaction between buildings and the atmosphere is not limited to the wind field and shading: the color and texture of the buildings surfaces define the radiative budget

within their vicinity. The structure and materials of the facades determine how much heat can be stored within the walls and how well heat is transferred between the inside of a building and the atmosphere on the outside. The combination of all physical properties define the surface temperature of the facade, which in turn influences the air temperature.

But not only urban planners looking at the microclimate would benefit from an accurate modeling of the energy exchange between facades and the atmosphere: it also helps architects and building engineers to better assess the amount of energy a building needs for cooling and heating and to monitor the feedback between the building and its vicinity.

5. SIMULATION

The simulation took place in a 99x99 grid with each grid having a size of 4x4 m². (Fig. 8) For accuracy and betterment of results It was decided that at least 14 extra grids from each side be added to each side of the last blocks. For the purpose of this article and according to the limitations of our simulation tool ENVI-met, a height grid size of 3m (1 floor) was chosen for simulations. The ENVI-met model of the simulated area (the 'Base Case') is shown in Table 4. The simulations were initiated using data obtained from a synoptic weather station at the Tabriz International Airport, approximately 8.65 km northwest of the measurement location. As it was not possible to simulate the conditions for a whole year with our simulation tool June 21 and December 21 were selected because they are summer and winter solstice and sun at noon is in its highest and lowest elevation (Table 2).

Table 2: Solar angles on June 21 and December 21 in Tabriz

Jun 21 st – 2016 (Summer Solstice)				Dec 21 st – 2016 (Winter Solstice)			
Sunrise	Sunset	Noon/Elevation	daylight	Sunrise	Sunset	Noon/Elevation	daylight
6:02:19	20:51:03	13:26:41	14:48:44	7:37:25	17:08:41	12:23:03	9:31:16
58.89°	301.1°	75.38°	---	119.59°	240.41°	28.5°	---

(Source:[30])

Solar radiation is calculated by the program based on latitude, longitude and time zone. By inputting the data shortwave solar radiation, solar access, sun hour, sky view factor is determined. The calculated global radiation can be adjusted by multiplying by a factor between 0.5 and 1.5 [31].

Also as input for ENVI-met its was decided that for all building and other variables every variable should be the same in all models so that we can get a better understanding of how sunlight works so all building were considered to be made of concrete as it is the usual material for buildings in Tabriz (Table 3).

Table 3: Input data for the simulations using ENVI-met

	Jun 21 st		Dec 21 st	
Temperature	5 AM – Min	4 PM – Max	6 AM – Min	4 PM – Max
	33.03°C	15.86°C	-7.51°C	10.46°C
Relative Humidity	4 PM – Min	5 AM – Max	3:30 PM – Min	6 AM – Max
	12.16%	57.33%	59.4%	91.4%
Wind Speed	4.72 m/s		1.83 m/s	
Wind Direction	82 degree		52 degree	

Humidity at 2500 m	7 [32]	
Roughness Length	0.01	
Start Time of Simulation	3:00 AM	
Total Simulation time	18 hours (3:00 AM – 9:00 PM)	
Shortwave adjustment factor	1	
Position on Earth	Longitude 46.30°	Latitude 38.05°

ENVI-met was run on an Intel Corei7 Sandy Bridge Processor running at 2GHz with 8GB of Ram on which the simulations took about 36 to 72 hours depending on the height and size of the modeled area.

For the purpose of this study variables such as: shortwave radiation received, sky view factor, surface / volume, sun hour, gross floor area, built area, open space needed to be calculated and the result of all the tested variables from the modeling and simulation were rounded up in Table 4.

Table 4: Main parameters of urban forms studied for solar radiation.

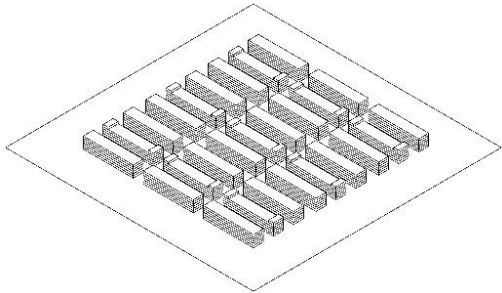
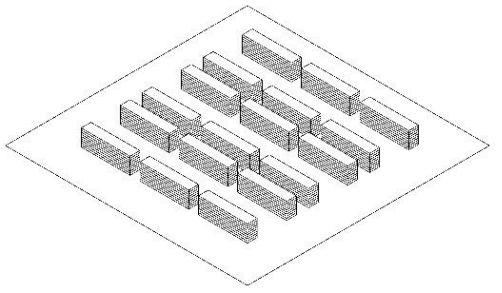
Module parameters	Layout (99 x 99 modules)
Urban Form: Type A2	
Module Size: 396x396 Block Length: 80m Block Height: 18,15m Street Width: 10,14m Built Area: 34560 Surface/Volume: 0.3 Units: 1548	Total Population:5109 Building Width:16m Open Space: 122256 Gross Floor Area:198144 Floor Space Index:5.73 Wall to Floor Ratio:0.46 Sky view factor:0.680 
Urban Form: Type B2	
Module Size: 396x396 Block Length: 80m Block Height: 27m Street Width: 10,14m Built Area: 23040 Surface/Volume:0.18 Units:1620	Total Population:5346 Building Width:16m Open Space:133776 Gross Floor Area:207360 Floor Space Index:9 Wall to Floor Ratio:0.45 Sky view factor:0.673 
Urban Form: Type C2	

Module Size: 396x396	Total Population:3564
Block Length: 80m	Building Width:16m
Block Height: 36m	Open Space:145296
Street Width: 10,14m	Gross Floor
Built Area: 11520	Area:138240
Surface/Volume:0.096	Floor Space Index:12
Units:1080	Wall to Floor
	Ratio:0.45
	Sky view factor:0.755

5. RESULTS AND DISCUSSION

The primary intention of this paper is to improve the energy efficiency of urban form. While this translates directly into an energetic advantage, there are various other benefits like better day lighting and passive solar gains and increase photovoltaic potential which help reduce space heating demands and create energy. In This case 3 urban districts are planned with such design guidance the overall urban form would have substantial improvement in both demand and supply potential of urban energy consumption. Sky view factor was calculated using the 2 dimensional export and removing the building grids and then calculated the average. Results from this case study are both in 3D and 2D graphical format that show the value of each grids cell bye cell. Fig. 12, Fig. 13, Fig. 14 and Fig. 15 are some examples of the simulations done by ENVI-met for the purpose of this article.

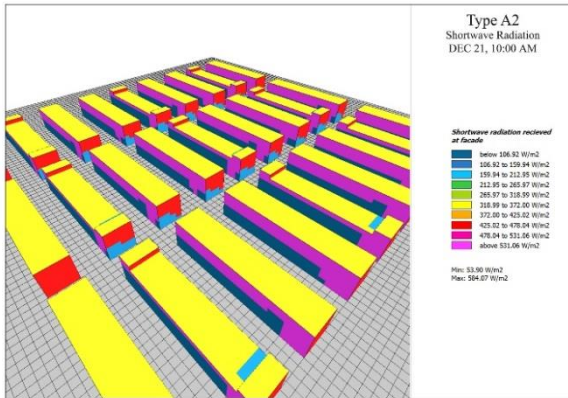

Figure 12. Simulated SWR for Type A2 (DEC21,10AM)

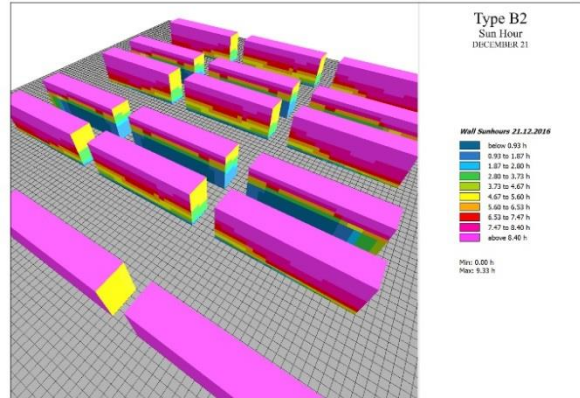

Figure 13. Simulated Sun Hour for Type B2 (DEC21)

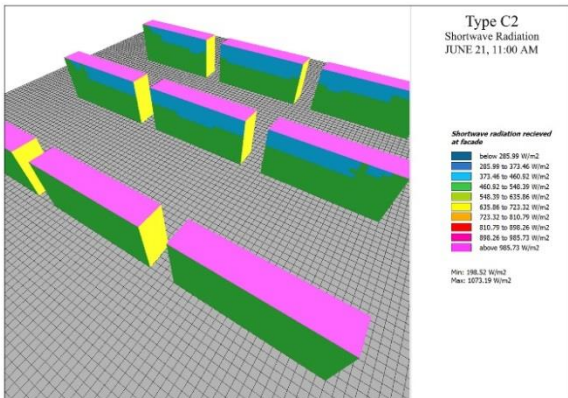

Figure 14. Simulated SWR for Type C2 (JUN21,11AM)

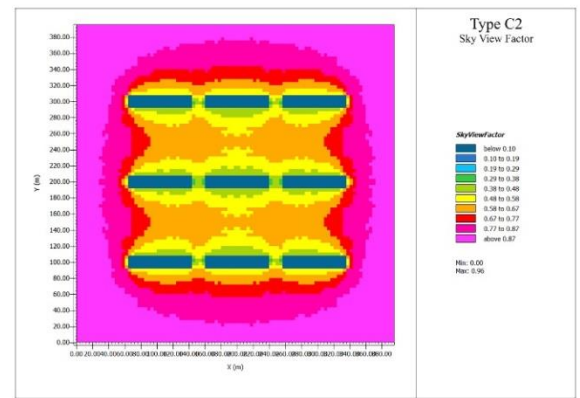

Figure 15. Simulated Sky View Factor for Type C2

Each of the parameters was then analyzed in a comparative way for understanding of their maximum, average and minimum amount and results seen from each analysis was then described and gathered in Table 5.

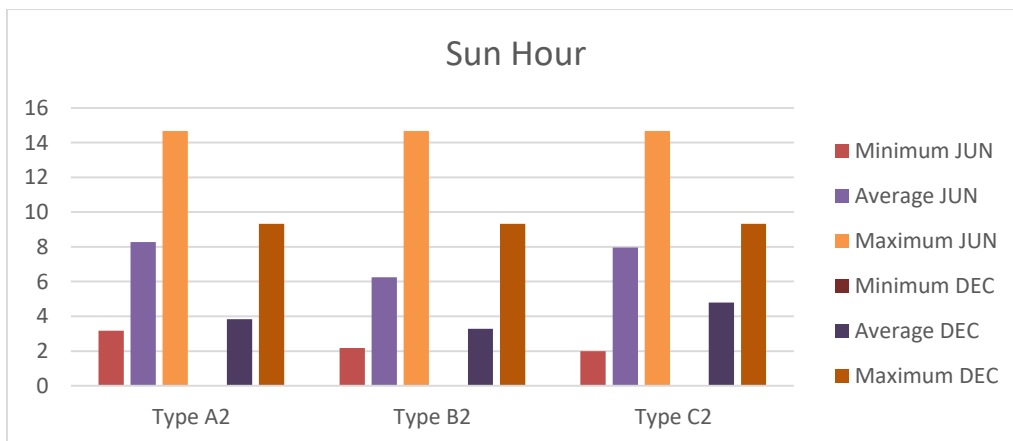

Figure 16. Sun hour (Min, Average and Max for December 21 and June 21)

First Parameter was Sun hour. It was calculated by summing up all the grids on all facades of the simulated model and then calculating the average amount for June 21 and December 21 (Fig. 16).

The results of simulation concerning sun hour showed height and positioning of the buildings does not affect the maximum sun hour they can receive while average and minimum differ. As observed the lowest minimum is for Type C2 on June 21st and Type B2 is 2nd lowest; while the lowest average is for Type B2 and 2nd lowest is for Type C2 on June 21st; although the highest average is for Type C2 and 2nd highest is for A2 on December 21st.

2nd step was calculating Min, Max and Average amount of shortwave radiation received by facades of every urban block type and then comparing the average amount of shortwave radiation received by facades in a whole day, Figs. 17-20.

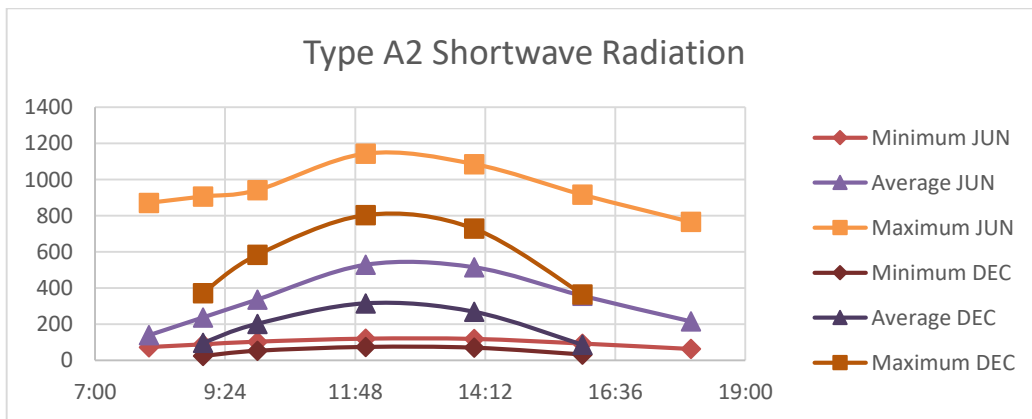

Figure 17. Type A2 Shortwave Radiation (Min, Average and Max for December 21 and June 21)

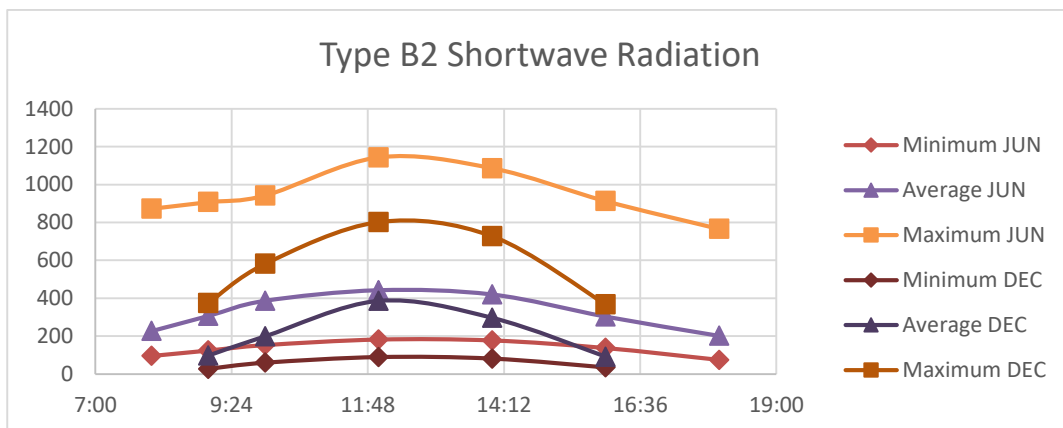

Figure 18. Type B2 Shortwave Radiation (Min, Average and Max for December 21 and June 21)

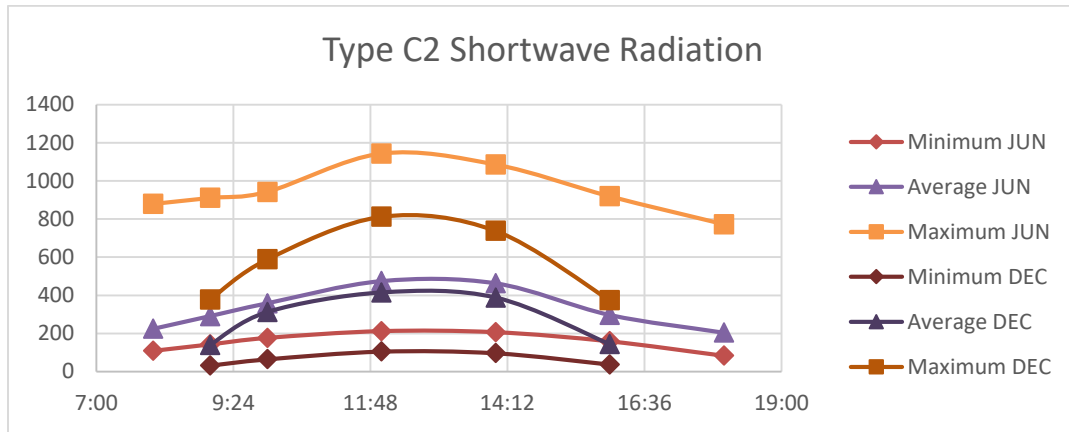

Figure 19. Type C2 Shortwave Radiation (Min, Average and Max for December 21 and June 21)

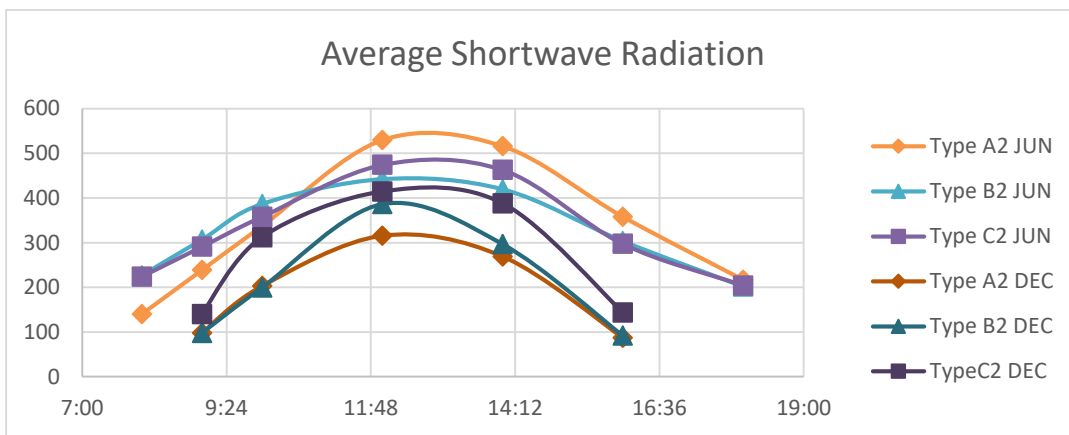

Figure 20. Average Shortwave Radiation received by facades of every Scenario on December 21 and June 21

By analyzing the above results as the simulation’s diagram slope show the maximum SWR is lesser in the afternoons than in the mornings on June 21st.as observed highest minimum for SWR is for Type C2 and then for Type B2 on Jun 21st and December 21st. however highest average for SWR is for Type C2 and then Type B2 on December 21st but on June 21st highest average for SWR is for Type A2 and then Type C2. I can also be seen that the positioning of the building and its height does not seem to have much effect on the maximum amount of Shortwave radiation. As the diagrams also illustrate on December 21st, due to low solar angle it was observed that the amount of SWR received by the southern façade was higher than the amount received by the roof but, on June 21st the amount of SWR received by the roof was higher than other surfaces of the building due to higher solar angle.

Table 5: Data gathered by examination of the results

	Type A2	Type B2	Type C2
Shortwave Radiation Received	✘ Highest average on JUN 21 st	✔ Lowest average SWR on JUN 21 st	✔ Highest average on DEC 21 st

	✗ Lowest average on DEC 21 st	✓ 2nd highest average on DEC 21 st	✓ 2nd lowest average on JUN 21 st
	✓ 2nd highest on DEC 21 st	✓ Lowest average on JUN 21 st	✓ Highest average on DEC 21 st
Sun Hour	✗ Highest average on JUN 21 st	✓ Minimum almost the same as Type C2	✓ 2nd lowest on JUN 21 st
	✗ Highest minimum sun hour on JUN 21 st	✗ Lowest average on DEC 21 st	✓ Minimum almost the same as Type B2
Sky View Factor	✓ Almost the same as Type A2	✓ Almost the same as Type A2	✓ Highest SVF
Surface / Volume	✗ Highest	✓ 2nd lowest	✓ Lowest
Gross Floor Area	✓ 2nd highest	✓ Highest	✗ Lowest
Built Area	✗ Highest	✓ 2nd lowest	✓ Lowest
Open Space	✗ Lowest	✓ 2nd Highest	✓ Highest

6. CONCLUSION

3 type of urban blocks were chosen for comparison for their exposure to sunlight. Type A2 is an urban block with lowest height and higher density and floor area containing 27 blocks. Type B2 is higher than A2 and its floor area is less than A2 and has more open space. Type C2 is the highest and has more open space but density is lower than other types. The comparison between measurements and the results of the simulations performed with ENVI-met show the model output strongly depends on the quality of the data used for the forcing. In the presented case studies, the input profiles of air temperature, wind speed and direction and specific humidity are derived from the measurements of a weather station at the edge of the city, respectively 9km northwest of the model areas.

The simulations were conducted for each type and results showed that Type C2 (highest, more open spaces) is a more efficient style for winter times as it receives more of the sun's energy and also the amount of sun it gets during a day. However, type B2 (medium height and open space) is the better option for summer as it gets less energy from the sun and it is exposed to sunlight less than other types in a hot summer day.

As the model results show Type B2 (medium height and open space) the better choice energy wise if density and gross floor area matter more than floor area and open space in a specific area in Tabriz or maybe if we had height regulations in a specific area e.g. around a historical site. But Type C2 (highest, more open spaces) is also efficient and comes in a close 2nd as it gives more space for vegetation and open spaces and also the highest sky view factor than any other alternatives which in return can give us more freedom in landscape design. So urban designers and planners can develop policies for either of the types depending on which direction the city wants to go.

The results and proposed best pattern can also be generalized and used in the cities or

projects in the similar latitude and with the similar wind conditions and direction. Also its worth mentioning that the effects of wind speed, temperature, vegetation, humidity, wind direction, solar reflection and thermal comfort although lightly considered has not been critical for the purpose of this article and its conclusion but can be tested in later studies to get a more accurate and decisive decision for choosing the best scenario all-around.

Acknowledgments: The information contained in this article was extracted from a master's thesis by the author entitled (Designing a Low Carbon Neighborhood) under the supervision of Dr. Farzin Haghparast and Dr. Aida Maleki Maleki and advisement of Dr. Amir Shakibamanesh in Tabriz Islamic Art University.

REFERENCES

1. Mirgholami M, Aali A, Ghobadi P. The Effects of Sustainability Approaches on Urban Identity in Arabic Cities (Case Study: Masdar Zero Carbon City). *In Proceedings of the International Conference in Sustainability on Architecture and Urbanism Masdar City*; 2015.
2. Xing Y, Hewitt N, Griffiths P. Zero carbon buildings refurbishment-A Hierarchical pathway, *Renew Sustain Energy Rev* 2011; **15**(6): 3229-36.
3. Ibn-Mohammed T, Greenough R, Taylor S, Ozawa-Meida L, Acquaye A. Operational vs. embodied emissions in buildings-A review of current trends, *Energy Build* 2013; **66**: 232-45.
4. Cabeza LF, Rincón L, Vilarino V, Pérez G, Castell A. Life cycle assessment (LCA) and life cycle energy analysis (LCEA) of buildings and the building sector: A review, *Renew Sustain Energy Rev* 2014; **29**(2014): 394-416.
5. Zuo J, Zhao ZY. Green building research-current status and future agenda: A review, *Renew Sustain Energy Rev* 2014; 271-81.
6. International Energy Agency. Clean energy. Progress Report. IEA input to the Clean Energy Ministerial, *OECD / IEA* 2011, 67.
7. International Energy Agency (IEA). Statistics, 2014.
8. IEA. World Energy Outlook 2013. International Energy Agency, Paris, International Energy Agency, 2013.
9. Yau YH, Hasbi S. A review of climate change impacts on commercial buildings and their technical services in the tropics. *In Proceedings of the Renewable and Sustainable Energy Reviews* 2013, pp. 430-41.
10. Kelly G. Sustainability at home: Policy measures for energy-efficient appliances, *Renew Sustain Energy Rev* 2012; **16**(9): 6851-60.
11. Robert A, Kummert M. Designing net-zero energy buildings for the future climate, not for the past, *Build Environ* 2012; **55**: 150-8.
12. Nataly Echevarria Huaman R, Xiu Jun T. Energy-related CO₂ emissions and the progress on CCS projects: A review, *Renew Sustain Energy Rev* 2014; **31**: 368-85.
13. International Energy Agency. CO₂ Emissions from fuel Combustion. *IEA Statistics* = 2012;138. 14. Terjung WH, Louie SS-F. Solar Radiation and Urban Heat Islands, *Ann Asso Amer Geograph* 1973; **63**(2): 181-207.

14. Ghobadi P, Aali A. Strategies and Tools in Low Carbon Transport. *In Proceedings of the International Conference in Sustainability on Architecture and Urbanism Masdar City*; 2015.
15. Kanters J, Horvat M. Solar energy as a design parameter in urban planning, *In Proceedings of the Energy Procedia* 2012, pp. 1143-52.
16. Kanters J, Wall M, Dubois MC. Typical values for active solar energy in urban planning, *In Proceedings Energy Procedia* 2014, pp. 1607-16.
17. Maleki A, Mahdavi A. Evaluation of urban heat islands mitigation strategies using 3dimensional urban microclimate model ENVI-met, *Asian J Civil Eng.* 2016; **17**(3): 357-71.
18. Maleki A, Kiesel K, Vuckovic M, Mahdavi A. Empirical and computational issues of microclimate simulation. *Lecture Notes in Computer Science (including subseries Lecture Notes in Artificial Intelligence and Lecture Notes in Bioinformatics)* 2014, pp. 78-85.
19. Average Weather For Tabriz, Iran - WeatherSpark [Internet]. 2016 [cited 2016 Jul 26]. Available from: <https://weatherspark.com/averages/32837/Tabriz-Azarbayjan-e-Sharqi-Iran>.
20. Average Weather On June 21 For Tabriz, Iran - WeatherSpark [Internet]. 2016 [cited 2016 Jul 26]. Available from: <https://weatherspark.com/averages/32837/6/21/Tabriz-Azarbayjan-e-Sharqi-Iran>.
21. Average Weather On December 21 For Tabriz, Iran - WeatherSpark [Internet]. 2016 [cited 2016 Jul 26]. Available from: <https://weatherspark.com/averages/32837/12/21/Tabriz-Azarbayjan-e-Sharqi-Iran>.
22. Ketterer C, Matzarakis A. Comparison of different methods for the assessment of the urban heat island in Stuttgart, Germany. *Int J Biometeorol* 2014; **59**(9): 1299–309.
23. Rinke R, Kapp R, Reuter U, Ketterer C, Fallmann J, Matzarakis A, et al. Pilot Actions in European Cities -- Stuttgart. In: Musco F, editor. *In Proceedings of the Counteracting Urban Heat Island Effects in a Global Climate Change Scenario*, Cham, Springer International Publishing, 2016, pp. 281-303.
24. Yola L, Siong HC. Modeling and Simulation Approach of Assessing Urban Form (A Review), *In Proceedings of the International Conference at Malaysia* 2014, pp. 26.
25. Maleki A, Aali A, Ghobadi P. An Introduction of UrbaWind Software and its Application in Urban Design, *In Proceedings of the 3rd International Conference on Applied Research in Civil Engineering, Architecture and Urban Management*, Tehran: K.N.Toosi, University of Technology, 2016.
26. Ozkeresteci I, Crewe K, Brazel AJ, Bruse M. Use and Evaluation of the ENVI-met Model for Environmental Design and Planning: an Experiment on Linear Parks, South Africa, 2003, pp. 10-6.
27. Ali-toudert F, Mayer H. Planning-oriented Assessment of Street Thermal Comfort in Arid Regions, *The 21th Conference on Passive and Low Energy Architecture* 2004; **41**: pp. 19-22.
28. Huttner S. Further development and application of the 3D microclimate simulation ENVI-met, *Mainz: Johannes Gutenberg-Universitat in Mainz* 2012, 147.
29. Sunrise Sunset annual calendar, calculator: Azimuth, Noon Elevation, Daylight for Tabriz, Iran [Internet]. 2016 [cited 2016 Apr 12]. Available from: <http://www.sunearthtools.com/solar/sunrise-sunset-calendar.php#table>
30. Emmanuel R, Rosenlund H, Johansson E. Urban shading - A design option for the tropics: A study in Colombo, Sri Lanka, *Int J Climatol* 2007; 1995-2004.

31. Converter for humidity of air [Internet]. 2016 [cited 2016 Jul 26]. Available from: <http://www.cactus2000.de/uk/unit/masshum.shtml>.