



Vibration Control of Structures by Optimization of Peripheral Mass Dampers

M. Ramezani¹, M.R. Mohammadizadeh¹ and S. Shojaee^{2,*†}

¹ *Department of Civil Engineering, University of Hormozgan, Bandar Abbas, Iran*

² *Department of Civil Engineering, Shahid Bahonar University of Kerman, Kerman, Iran*

ABSTRACT

In recent years, there has been a lot of interest in the development and deployment of control methods that use different components of the building to mitigate the seismic response of the structure. Meanwhile, the building facade, as a non-structural component, can be a suitable alternative in affecting the structure's behavior because of its role as an envelope of the building with a significant weight. Among the modular cladding systems, the Double Skin Facade (DSF) can be considered a passive system due to the distance of the exterior layer from the main structure and sufficient continuity and rigidity. In this study, DSF systems are used as Peripheral Mass Dampers (PMDs) that control structural movements by dissipating energy during strong motions. The PMD system provides a building with several inherent dampers without the need for extra mass. To show the reliability and efficiency of the proposed approach, the PMD model is investigated and compared with results available in uncontrolled and Tuned Mass Damper (TMD) models. The PMD model is examined in three structural frames with 10, 20, and 30 stories with the extreme Mass Ratios (MRs) of 5% to 20%. The Particle Swarm Optimization (PSO) is performed on damper parameters of PMD and TMD systems to minimize structural responses. The results demonstrate that an optimal PMD system with multiple inherent mass dampers outperforms a single TMD system.

Keywords: Peripheral mass dampers, optimization, double skin facade, passive control, particle swarm optimization.

Received: 10 December 2022; Accepted: 12 January 2023

*Corresponding author: Department of Civil Engineering, Shahid Bahonar University of Kerman, Kerman, Iran

†E-mail address: saeed.shojaee@uk.ac.ir (S. Shojaee)

1. INTRODUCTION

In recent years, creative-focused design and construction technologies have been developed to increase the seismic safety of structures. The ability of the system to dissipate energy and the consequences of lateral deformation on the reaction of the entire building must be taken into account in seismic design, in particular [1]. For this goal, a variety of structural control concepts have been developed, and many of them have been used in constructed buildings. Among these concepts, the reduction of vibrational levels in flexible structures, the adaptation of existing structures to environmental hazards, the protection of seismic equipment and crucial secondary systems, and the design of structures to withstand environmental loading, can be mentioned. The idea of vibration control of structures, in such a way that the structure and control systems work together, was first presented by J.T.P. Yao nearly 50 years ago. Over the years, with the progress of these methods, the research in this area was divided into passive, active, semi-active, and hybrid systems [2]. Engineers and researchers usually use passive systems because of their availability and reliability. These systems improve the performance of the structures through the reduction of input energy, energy absorption, and isolation systems without the necessity for external power [3]. Among the passive control methods, Tuned Mass Dampers (TMDs) are widely used in tall buildings and bridges to withstand dynamic loads such as earthquakes and wind [4-7]. They are typically placed towards the top level of structures for the best function, where the greatest lateral displacement occurs. TMD was first presented by Frahm in 1909 [8] and afterward expanded by a large number of people. Den Hartog was the first to formulate the optimal design theory of TMD systems for an undamped single-degree-of-freedom (SDOF) main structure subject to harmonic loadings [9].

Researchers have demonstrated that the little offset in tuning, particularly for a broad range of ground motion frequency content and considerable vibration in higher modes of tall buildings, can reduce the efficiency of a single TMD in earthquake applications [3]. Therefore, the concept of using Multiple Tuned Mass Dampers (MTMDs) with variable dynamic features was applied by researchers and focused on the optimization of the systems under the dynamic loads. A major challenge in designing this system is a large number of damper parameters (i.e., mass, stiffness, and damping coefficient). Arfiadi and Hadi [10] used genetic algorithms to optimize TMD location and properties. Optimizing these parameters provides an effective and robust structural control system. Mohebbi et al. [11] studied the capability of optimal single and multi-TMDs to mitigate damage subjected to seismic excitation. Kamgar et al. [12] presented the optimal TMD system subjected to earthquakes considering the impacts of soil-structure interaction. Recently, Kaveh et al. [13,14] have investigated the optimum parameters of TMDs under seismic excitations by using a charged system search and chaotic optimization algorithm. Ozturk et al. [15] presented the ideal vertical location and design of tuned mass dampers for various ground motion parameters and models. Lu et al. [16] investigated the effects of multi-mode control for mitigating the vibration of earthquake-resistant high-rise buildings with a wide vibration suppression frequency band. Although these systems worked as energy absorption frameworks, they had several drawbacks such as the complexity of design and the need for large space for installation. Another method of controlling structural movement has been proposed using a cladding system containing energy absorbers that attenuate the amount of

energy transferred to the primary structure during ground excitation. To date, engineers have viewed structural facade systems as non-structural elements of high aesthetic value and barriers between external and internal environments. As an integral part of all structures, if not properly designed, they are vulnerable to potential failure when exposed to environmental hazards such as earthquakes and winds. If the connection details are imperfect, the facade can withstand a lot of stress under seismic loads, leading to damage and warping [17].

Engineers have recently debated and given importance to the use of new cladding solutions to control the seismic response of structures. Many facade systems, including glass curtain walls, stone panels, and precast concrete panels, have been used in tall structures. Most of these systems are typically multi-layered, although there are very few gaps between the levels. Due to the second skin's space from the main structure, the Double-Skin Facade (DSF) has received the majority of research attention. While little is known about the seismic behavior of this system, several recent studies have concentrated on the characteristics and uses of DSF regarding environmental conditions and energy savings [18,19]. Moon [20] was the first to investigate the use of vibration control systems to improve the dynamic performance of tall buildings under wind pressures and seismic events. According to the other Moon's research [21], DSF-distributed mass dampers could handle problems like giving up priceless occupiable space near the top of tall structures. Fu et al. [22] proposed an integrated control system to combine DSF and mass dampers in buildings. They demonstrated that energy efficiency may be increased by motorizing the DSFs, and their findings suggested that mass damper systems can dramatically reduce structure vibrations during seismic excitation. Palmeri et al. studied the effect of distributed mass dampers on multi-story buildings under a series of seismic motions [23]. They used genetic algorithm techniques to find the optimal design parameters for the DSF panel.

In early research, evaluations were conducted with a primary focus on the environmental applications, energy considerations, and the role of the DSF system as a vibration absorber during earthquake excitation. In actuality, the approachable references did not contain any in-depth studies on DSF structures focusing on the optimization of mechanical parameters of mass dampers in the DSF systems. In an applied research, Anajafi et al. used the partial isolation technique and compared their system with single TMD and base isolation systems [24]. Furthermore, Pipitone et al. [25] used a variety of DSF layouts with mass dampers to reduce seismic vibration in structures subjected to various earthquake excitations. Based on numerical analysis, they proposed an optimized DSF design configuration. In this way, Zang et al. investigated a new distributed MTMD system that greatly improves the structural movements [26].

The most elaboration aspect of designing this system is the high number of damper parameters (i.e., mass, stiffness, and damping coefficients); that as a result of optimizing these values, an effective and reliable structural control system is conducted. Today, with growing problems and an increasing number of variables, the speed of solving structural optimization problems is critical. One of the factors that have led to a significant increase in the use of intelligent random methods is the appropriate non-responsibility of classic optimization methods. The Particle Swarm Optimization (PSO) algorithm is a swarm Intelligence approach for tackling optimization problems. Kennedy and Eberhart introduced PSO, an optimization technique based on probabilistic rules [27]. A standard PSO algorithm

is started with a group of random potential solutions (particles). PSO has been used to solve a variety of real-world problems [28-30].

This paper investigates the Peripheral Mass Damper (PMD) system to mitigate vibration in seismic structures. The PSO optimization algorithm is used to acquire the specifications of dampers that connect the peripheral facade system to the main structure. The PMD system is investigated in three reference structural models of 10, 20, and 30 stories, which can represent common mid- and high-rise buildings. Multiple performance objectives are developed and evaluated to account for various structural responses. An optimization approach is proposed to select the parameters of the PMD, while limitations are specified to limit the isolated facades' reactions. The numerical results for a case study using a facade with 5%, 10%, 15%, and 20% mass ratio (MR) of the structure are shown. A dynamic analysis of the response by time history is used for 12 earthquake records. To prove and show the model's accuracy in controlling the vibration of seismic structures, the PMD model is compared to results from uncontrolled and traditional passive TMD.

2. PERIPHERAL MASS DAMPERS SYSTEM

The design concept of building structures equipped with vibration control devices and dissipative energy takes inspiration from TMD concept and the implementation in traditional facade connectors are able to act as passive impact absorbers. In this research, the PMD system is considered to achieve the passive control systems aim to reduce structural responses. According to the above, the peripheral mass system has been used as the mass distributed at the height of the structure to achieve the mentioned goal. The second skin of DSF system is assumed to be connected all around the perimeter of the structure. Two different configurations for facade system are chosen in this investigation as shown in Figure 1.

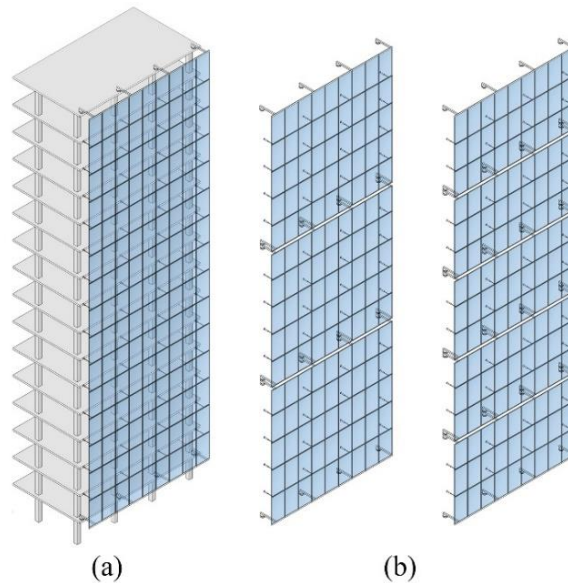

Figure 1. PMD layouts: (a) 1-Panel model. (b) N-Panel models

In the first layout , which is called 1-panel layout, the facade frame is connected to the main structure at all floor levels using viscous dampers, (Figure 1(a)). In the second layout, as N-panel layout, the facade is divided in its height into number of panels where viscous devices connect the facade frame to the main structure at all floor levels as shown in Figure 1(b). Such arrangements for facade systems are chosen to investigate the role of facade frame continuity along the height of the building.

To consider the PMD system, we can model the system through a multi-degree of freedom (MDOF) spring-mass system. In this model, the building is divided into two parts, the main structure and the facade, so that the facade mass is concentrated separately from the mass of the structure. The primary structure is modeled as a two-dimensional, linear-elastic shear frame with equal floor mass and lateral stiffness as well as a viscous damping ratio that is considered to remain constant across all vibrational modes. A simplified scheme of the n-story that using PMD model is shown in Figure 2(b) and (c).

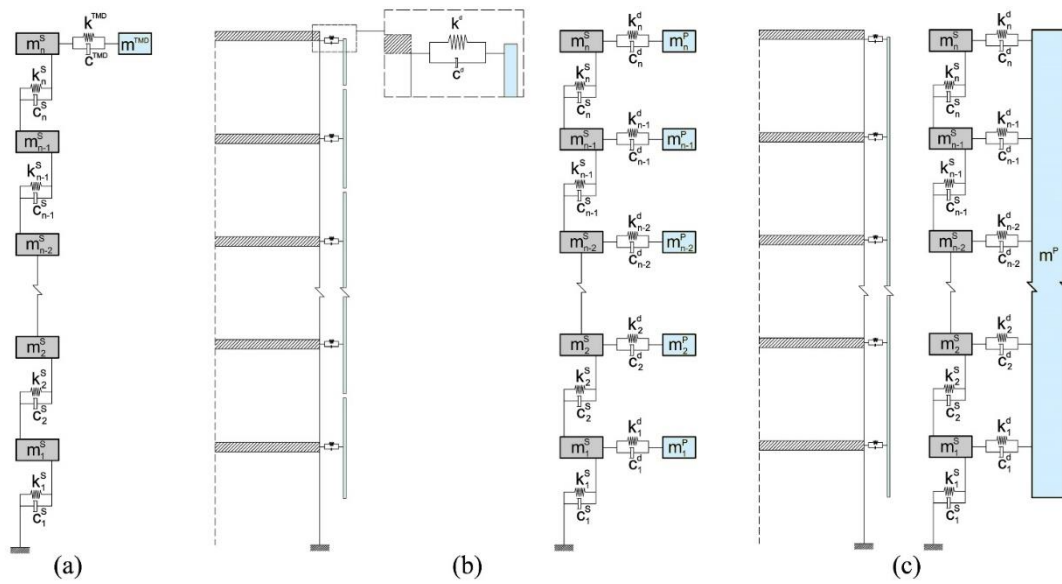

Figure 2. PMD layouts: (a) 1-Panel model. (b) N-Panel models

In model, story masses are lumped at floor levels, and a single lateral degree of freedom is assigned at each of them. The same assumption is adopted for modeling the mass damper in the TMD system. Figure 2(a) shows a n-story structure with a TMD effects. The PMD is modelled as a set of independent panels similar to Figure 2(b) as N-Panel layout and continues facade panel shown in Figure 2(c) as 1-Panel layout. In N-Panel layout each panel studied as a lumped mass system connected to the main structure by elastic springs and dampers at the floor levels. Consider a multiple-PMD system with n stories and m facade panels, where $n = rm$. Here, r is a scalar value, which implies that m is chosen to be able to divide n. In simulations, this system with uniformly divided facades was chosen for its convenience and adaptability.

The equation of motion for the n-story building with a PMD system shown in Figure 2 can be expressed as follows if the dynamic system is driven by the unidirectional ground

acceleration, $\ddot{x}_g(t)$:

$$M\ddot{x}(t) + C\dot{x}(t) + Kx(t) = -M\ddot{x}_g(t) \tag{1}$$

where the PMD characteristics matrix including mass matrix, M, stiffness matrix, K, and damping matrix, C, are given by:

$$M = \begin{bmatrix} M^S & 0 \\ 0 & M^P \end{bmatrix}_{(n+m) \times (n+m)}, \quad K = \begin{bmatrix} K_{11} & -K_{12} \\ -K_{12} & K_{22} \end{bmatrix}_{(n+m) \times (n+m)}, \quad C = \begin{bmatrix} C_{11} & -C_{12} \\ -C_{12} & C_{22} \end{bmatrix}_{(n+m) \times (n+m)} \tag{2}$$

In this equation,

$$M^S = \begin{bmatrix} m_1^S & 0 & \dots & 0 \\ 0 & \ddots & & \vdots \\ \vdots & \dots & m_{n-1}^S & 0 \\ 0 & \dots & 0 & m_n^S \end{bmatrix}_{n \times n}, \quad M^P = \begin{bmatrix} m_1^P & 0 & \dots & 0 \\ 0 & \ddots & & \vdots \\ \vdots & \dots & m_{m-1}^P & 0 \\ 0 & \dots & 0 & m_m^P \end{bmatrix}_{m \times m} \tag{3}$$

$$K_{11} = \begin{bmatrix} k_1^S + k_2^S + k_1^d & -k_2^S & \dots & 0 \\ -k_2^S & \ddots & & \vdots \\ \vdots & \dots & k_{n-1}^S + k_n^S + k_{n-1}^d & -k_n^S \\ 0 & \dots & -k_n^S & k_n^S + k_n^d \end{bmatrix}_{n \times n}, \quad K_{22} = \begin{bmatrix} \sum_{i=1}^r k_i^d & 0 & \dots & 0 \\ 0 & \sum_{i=r+1}^{2r} k_i^d & & \vdots \\ \vdots & \dots & \ddots & 0 \\ 0 & \dots & 0 & \sum_{i=(m-1)r+1}^{mr} k_i^d \end{bmatrix}_{m \times m} \tag{4}$$

$$K_{12} = \begin{bmatrix} k_1^d & k_2^d & \dots & k_r^d & 0 & 0 & \dots & 0 & \dots & 0 & 0 & 0 & 0 \\ 0 & 0 & \dots & 0 & k_{r+1}^d & k_{r+2}^d & \dots & k_{2r}^d & & 0 & 0 & 0 & 0 \\ \vdots & & & & & & & 0 & \ddots & & & & \vdots \\ 0 & 0 & \dots & 0 & 0 & 0 & \dots & 0 & \dots & k_{(m-1)r+1}^d & k_{(m-1)r+1}^d & \dots & k_{mr}^d \end{bmatrix}_{n \times m} \tag{5}$$

C takes a form similar to K, respectively, that $c_i^S = 2\xi_1^S \sqrt{k_i^S m_i^S}$, $c_i^d = 2\xi_i^d \sqrt{k_i^d m_i^P}$. The superscripts S, P and d stand for the main structure and facade panels and dampers between the main structure and facade, respectively. In accordance with Figure 2, m_i^P represents in fact the mass of a facade panel, while k_i^d and c_i^d denote, respectively the stiffness and damping coefficient and, ξ_i^d is the damping ratio of the dampers.

3. PMD OPTIMIZATION CRITERIA

The optimal design of the PMD system for the main structure as vibration control devices is not simple and is depended on the number and mass of facade panels (m_i^p), the characteristic parameters of dampers (k_i^d and c_i^d) as well as the target of the optimization problem. Structure responses are significantly reduced when the PMD model is optimized and tuned based on structural vibration modes. The objective function and variations in mass, stiffness, and damping parameters are used to develop this optimal process. In the topic of optimization, the objective function is defined based on the system demands and as a function of the decision variables.

In order to obtain the best parameters for PMD, the Particle Swarm Optimization (PSO) is employed. The PSO algorithm is one of the development algorithms inspired by real-world models that involve a number of particles that are randomly initialized in the search space of an objective function. These particles are known as swarms. Each swarm particle represents a possible solution to the optimization problem. Computing the updated specification of each particle which is associated with the position and velocity of the i -th particle in t -th iteration, is relied on particulars, namely the best and the global best position of them. The following expression based on the inertia weight (ω); two random numbers (r_1, r_2) in the range of $[0,1]$, and the cognitive and social scaling parameters (c_1, c_2):

$$Vel^{t+1}(i) = \omega Vel^t(i) + c_1 r_1 (POS_{best}^t(i) - POS^t(i)) + c_2 r_2 (GPOS_{best}^t - POS^t(i)) \quad (6)$$

$$POS^{t+1}(i) = POS^t(i) + Vel^{t+1}(i) \quad (7)$$

The performance of PSO is very sensitive to the inertia weight (ω) parameter which may decrease with the number of iterations as follows:

$$\omega = \omega_{max} - \frac{\omega_{max} - \omega_{min}}{t_{max}} t \quad (8)$$

where ω_{max} and ω_{min} are the maximum and minimum values of ω , respectively; and t_{max} is the limit numbers of optimization iteration.

In this work, various design solutions that satisfy various optimization criteria are compared using six optimization strategies. Different methods are being considered to change the PMD configurations and the optimization criteria. To decrease the time required for an optimization process, a displacement-based optimization method is suggested. For this, the root-mean-square (RMS) displacement of the last story is observed. The first recommended optimization method is based on the following objective functions:

$$J_{Dis} = \frac{RMS(x_n)^C}{RMS(x_n)^U} \quad (9)$$

where $RMS(x_n)^C$ and $RMS(x_n)^U$ are the RMS of the displacements of the last story of the main structure due to the each earthquake record, in the state of controlled and uncontrolled structure, respectively. The second objective function has been defined as the average of J_{Dis} for 12 records. Because the PMD model is linear, then,

$$J_{ADis} = \frac{1}{EQ} \sum_{i=1}^{EQ} J_{Dis,i} \quad (10)$$

Two additional optimization approaches have also been considered to account for the primary structure's serviceability. In this scenario, the RMS acceleration of the roof level of the main structure has been evaluated, and the following objective functions have been created, similarly to the displacement-based optimization problem, the following objective functions have been defined:

$$J_{Acc} = \frac{RMS(\ddot{x}_n)^C}{RMS(\ddot{x}_n)^U} \quad (11)$$

$$J_{AAcc} = \frac{1}{EQ} \sum_{i=1}^{EQ} J_{Acc,i} \quad (12)$$

The last two objective function is related to reduce inter-story drift responses because excessive inter-story drifts cause seismic damage to structural as well as nonstructural components. For a given passive control system, an optimal solution of the system parameters can be derived by minimizing the RMS of inter-story drift responses for each earthquake and average of 12 earthquakes:

$$J_{Drift} = \frac{RMS(x_i - x_{i-1})^C}{RMS(x_i - x_{i-1})^U} \quad (13)$$

$$J_{ADrift} = \frac{1}{EQ} \sum_{i=1}^{EQ} J_{Drift,i} \quad (14)$$

where x_i the displacement relative to the ground at the i -th floor level.

4. SEISMIC EXCITATION

All the objective functions have been defined in terms of the RMS responses, calculated in the observation time window $t \in [t_a, t_b]$. These limits are determined by $H(t)$:

$$H(t) = \frac{\int_0^t \ddot{x}_g^2(t) dt}{\int_0^{t_{eq}} \ddot{x}_g^2(t) dt} \quad (15)$$

where t_{eq} is the duration of the earthquake. The strong motion phase of a given seismic record is bounded by the time instants $t_{0.05}$ and $t_{0.95}$ at which $H(t)$ takes the values 0.05 and 0.95, respectively. The extremes t_a and t_b have been computed for each accelerogram as $t_a = t_{0.05}$ and $t_b = t_{0.95} + t_{tr}$, in which the transient time t_{tr} satisfies the condition:

$$e^{-\xi_0 \omega_0 t_{tr}} = 0.05 \quad (16)$$

that t_{tr} is the time required for the seismic response of the main structure in its first mode of vibration to reduce to 5% of its amplitude at the end of the strong motion phase [31].

For each of the six configurations, the displacement-, acceleration- and drift-based objective functions, considering the 12 excitations reported in Table 1. A series of actual near-fault and far-fault ground motions collected and the 0.05-damped pseudo-spectral acceleration responses for the selected records are illustrated in Figure 3.

Table 1. Set of earthquake records used for the numerical optimization

No.	Earthquake	Date	Mw	PGA(g)
1	Kobe	16/01/1995	6.90	0.344
2	Northridge	17/01/1994	6.69	0.568
3	Landers	28/06/1992	7.28	0.416
4	Kocaeli	17/08/1999	7.40	0.349
5	Loma Prieta	18/10/1989	6.93	0.367
6	Elcentro	18/05/1940	6.90	0.318
7	San fernando	09/02/1971	6.61	0.224
8	Manjil	21/06/1990	7.40	0.514
9	Tabas	16/09/1978	7.40	0.323
10	Erzican	13/03/1992	6.69	0.496
11	Chi-Chi	20/09/1999	7.62	0.361
12	Imperial Valley	15/10/1979	6.50	0.349

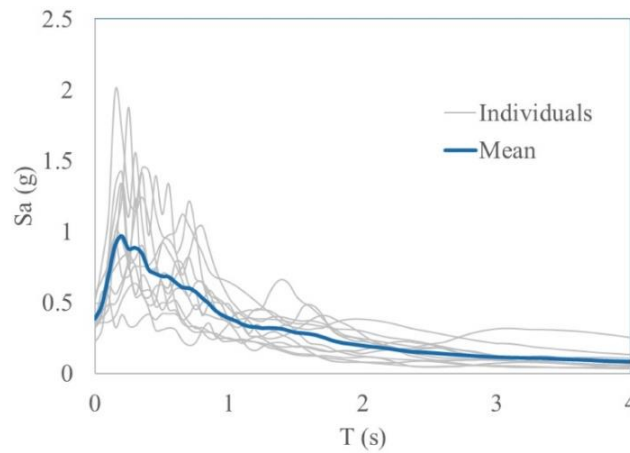

Figure 3. 0.05-damped ground response spectra for the 12 selected ground motions records

5. NUMERICAL EXAMPLES

In-order to check the performance of PMD system to control seismic vibration of structures, structural models with 10, 20, and 30 stories are selected and the results for each model are examined separately. The model consists of two parts: the main and also the peripheral structure (facade panels) that interconnected by dampers. In these two-part models, structural damping of the main structure is supposed to be Rayleigh damping. The dynamic characteristics of the structural models are presented in Table 2. Fundamental periods for the main structures are calculated as 1, 2, 3 (s) for 10-, 20- and 30-story model, respectively. Two different layouts have been studied to analyze different combinations of facade panels that include a N-Panel and 1-Panel that connected to main structure on each floor with connectors at the interface between the frame and the facade. The facade is considered as a mass damper system connected to the main structure with four different 5%, 10%, 15% and 20% MRs.

Table 2. The dynamic characteristics of the structural models

Structure	Stiffness Coeff. (N/mm)	Story mass (ton)	Fundamental Freq. (rad/s)	Fundamental Period (s)
10-story	3.48e4	20	6.27	1
20-story	3.34e4	20	3.14	2
30-story	3.29e4	20	2.1	3

In this research, PSO algorithm is used for determining the properties of dampers that connect facade with the main structure. For each of TMD and the two layouts, the objective functions (J_k) presented in optimization section have been minimized using the PSO algorithm; As a result, there will be several optimization issues that each of them can be formally written as:

$$\begin{aligned} \text{Given: } & m^s, k^s, \xi^s, \ddot{x}_g(t) \\ \text{Find: } & T^d, \xi^d \end{aligned} \quad (16)$$

To minimize: J_k

Such that:
$$\begin{cases} T_l \leq T^d \leq T_u \\ \xi_l \leq \xi^d \leq \xi_u \end{cases}$$

In which $T_l = 0.95T_{Fund.}$ and $T_u = 1.5T_{Fund.}$ referred to lower and upper bounds of the period, respectively; also $\xi_l = 2\%$ and $\xi_u = 20\%$. In order to get consistent physical results, these values are chosen for numerical limitations in design variables. Thus, concerning this limitation, the value of inherent structural damping ratio could be selected 20% maximum [32]. Note that the optimal specifications for TMD are within the practical range suggested for tall and slender structures [33].

Figure 4 shows the overall response of the system, with ten mass dampers for 10-story model, in terms of the objective functions for all the selected records. In each earthquake excitation, the diagram shows the range of variation of the objective functions (grey lines). To check the acceptability of the results of each earthquake, the optimal values of single earthquakes compare with the optimal values of the average objective function. It is well known that the response due to the control characteristics of the average optimal function in all earthquakes is close to the minimum value.

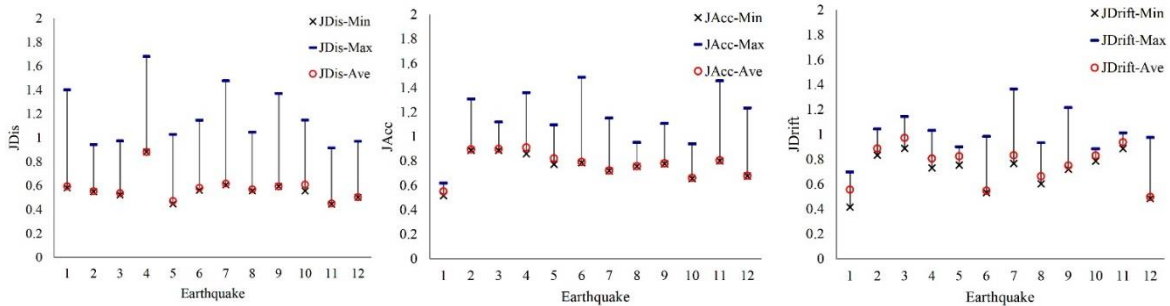

Figure 4. Single and average objective functions of N-Panel PMD model under the 12 seismic records

6. OPTIMAL PMD SYSTEM BASED ON DISPLACEMENT CRITERION

The assessment of displacements is critical in modern structural engineering practice due to the substantial connection observed between structural and non-structural element deformations. Modern structural optimization issues can be stated in a variety of ways, with potentially similar answers. The independent variables are selected differently in these formulations, as are the governing equations and the form of the constraint equations. Specific formulation characteristics have a considerable impact on the solution process and its efficiency. For structural optimization issues, displacement-based optimization methods provide a relatively successful formulation. It uses structural response displacements as unknown design factors to derive structural dimensions for maximum performance.

In this section, a displacement based optimal design of 2D PMD frames is presented based on roof displacement criteria. Four MR's defined by two layouts for 10-, 20- and 30-story

models. Displacement-based optimization is considered and frames have subjected to 12 earthquake excitations. Figure 5 demonstrates the variation of displacement average objective function versus the control systems' parameters for PMD models. The reduction in response is quite noticeable in all buildings with different heights, even though the maximum reduction occurred at 20-story model. As seen, the range of optimal periods in all models is close to the main period of the structure. The optimal damping values is also close to the upper limit that is considered.

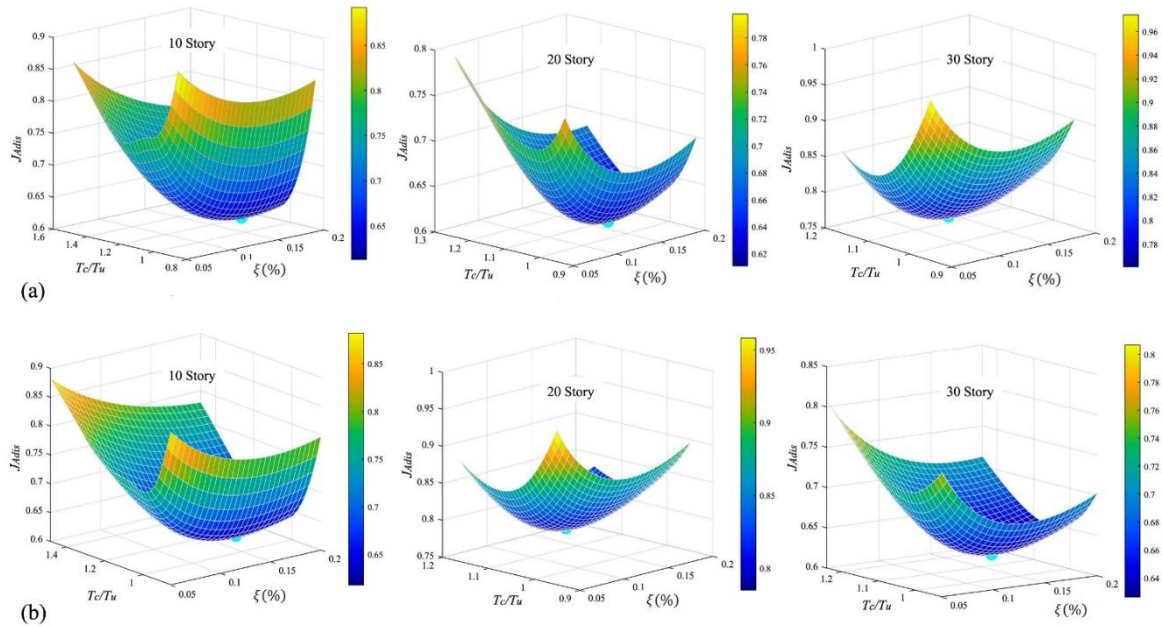

Figure 5. Variation of optimum parameters with respect to average displacement objective function a) N-Panel PMD model, (b) 1-Panel PMD model

The identified optimum parameters of the PMD and TMD models when the seismic loading is acting on the structure are summarized in Table 3. It is observed from Table 3 that for PMD models in all cases the greatest reduction is achieved for MR values close to 20%, and ξ^d values between 0.15 to 0.2. Both the PMD and TMD models contribute to the total reduction of the response. The maximum reduction achieved with the use of the PMD N-Panel system and about 44%, 45%, and 33% for 10-, 20- and 30-story model, respectively.

Table 3. Identified optimum parameters obtained by displacement-based optimization

Model	10 Story				20 Story				30 Story			
	MR _{opt}	T _{opt}	ζ _{opt}	Red.(%)	MR _{opt}	T _{opt}	ζ _{opt}	Red.(%)	MR _{opt}	T _{opt}	ζ _{opt}	Red.(%)
TMD	5	1.05	19.8	39.15	10	2.1	20	41.61	15	3.15	20	30.8
N-Panel	20	1.17	20	44.32	20	2.12	16.5	45.93	20	3.44	16.5	33.54
1-Panel	20	1.12	19.4	44.1	20	2.07	15	45.79	20	3.37	15.8	31.77

Figure 6 shows the variation of average displacement objective function, at the optimal damper parameters, with respect to MR, for PMDs and TMD models.

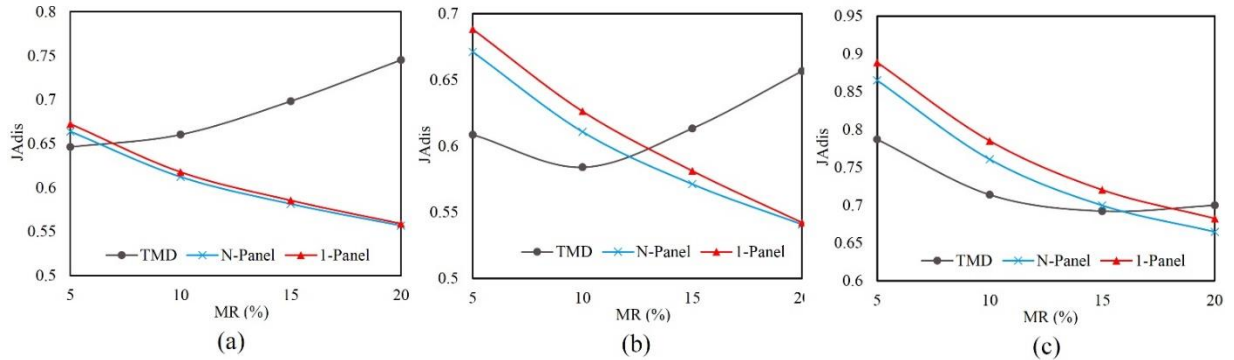

Figure 6. Optimum values of displacement objective function for different MRs (a) 10-story model (b) 20-story model (c) 30-story model

The results of displacement optimization show that, with increasing the facade MR, the reduction of the response of the PMD models is more and also the N-Panel system with 20% MR is the most efficient Model. Also, it is observed in Figure 6 that by increasing the height of the structure the form of the TMD response diagram is closer to the response of PMDs model and the optimal response is obtained at higher MR values.

7. OPTIMAL PMD SYSTEM BASED ON ACCELERATION CRITERION

The maximum floor acceleration is the other global engineering demand parameter taken into account in this study. The damage to acceleration-sensitive building elements, such as the cladding system, ceiling system, and mechanical equipment, is predicted using floor accelerations. In this case, the RMS acceleration of the top story of the main structure has been considered as J_{Acc} and J_{AAcc} . Similarly, to the previous section, Table 4 displays the results of the average acceleration-based optimization, which minimizes the objective function J_{AAcc} for all MRs and Models.

For better appreciate the variation of the average acceleration function with respect to ξ^d and T_c/T_u , Figure 7 shows the response of the N-Panel model for 10-, 20- and 30-story building, respectively. As shown T_c and T_u referred to period of controlled and uncontrolled structure, respectively. It is observed in Figure 7 that, as expected, the response is reduced with the use of the TMD and PMD systems. In TMD model the objective function has a lower value compared to other models and like the displacement-based optimization function, the range of optimal periods in all models is close to the main period of the structure and damping values close to the ξ^d upper bound.

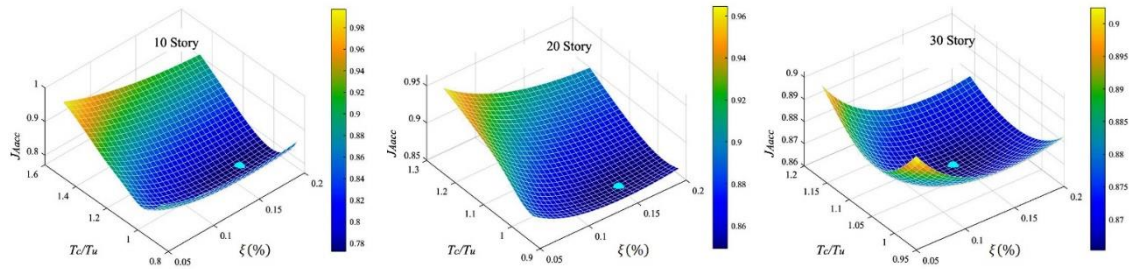

Figure 7. Variation of optimum parameters with respect to average acceleration objective function for N-Panel PMD model

Table 4 shows the optimum results of the average acceleration-based optimization. Among the responses analyzed, the acceleration at the top of the building and the TMD system is the one that presents the greatest reductions whereas the 1-Panel layout is the one with the smallest reduction.

Table 4. Identified optimum parameters obtained by acceleration-based optimization

Model	10 Story				20 Story				30 Story			
	MR _{opt}	T _{opt}	ζ _{opt}	Red.(%)	MR _{opt}	T _{opt}	ζ _{opt}	Red.(%)	MR _{opt}	T _{opt}	ζ _{opt}	Red.(%)
TMD	20	1.05	20	39.42	20	1.9	20	34.39	20	3.12	20	30.46
N-Panel	20	1.02	20	27.36	20	1.93	17	20.93	20	3.24	19.5	13.54
1-Panel	20	0.99	17.9	25.71	20	1.93	14.2	18.67	20	3.26	16.1	11.79

It is clear from Table 4 that the models with larger isolated mass (MR=20%) have better results. The range of periodic changes of the optimized model in all 10-, 20-, and 30-story models is close to the main period of the structure. The damping coefficient of dampers for TMD system is 20%, and for PMD models varies close to the upper limit that is considered.

The top floor accelerations were measured and Figure 8 shows a comparison of the top floor time history acceleration of 10-story model for uncontrolled, TMD and PMD models with different MRs under #1 earthquake record. It is observed from Figure 8 that the Maximum acceleration reduction is not very noticeable, but the RMS value in all three models is significantly lower than the uncontrolled structure.

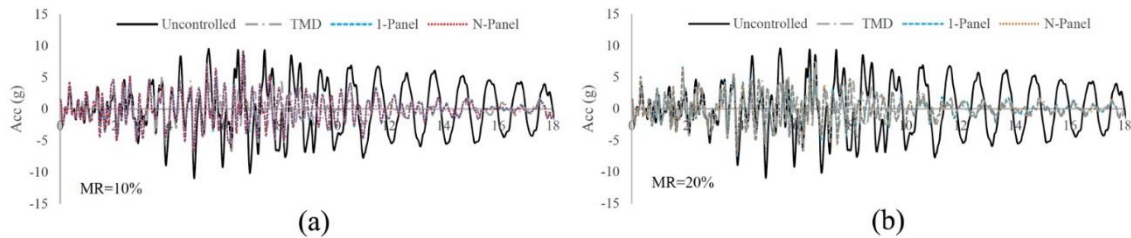

Figure 8. Top acceleration of 10-Story model under the seismic record #1 (a) 10% MR (b) 20% MR

8. OPTIMAL PMD SYSTEM BASED ON DRIFT CRITERION

The inter-story drift performance of a multi-story building has been known as an essential measure of structural and non-structural damage to the building under various levels of seismic events. Controlling inter-story drift can also be thought of as a way to ensure that the building's all stories have the same level of ductility. A significant story drift may result in the occurrence of a weak story, which may cause catastrophic building collapse. Uniform story ductility on all floors for a multi-story building is frequently desired in seismic design.

The maximum inter-story drifts for uncontrolled structure and all optimized models are plotted in Figure 9. The results of both PMD layouts are very close to each other and have a significant reduction compared to the uncontrolled model. The performance of PMD models, especially with higher floors, is much better than TMD system.

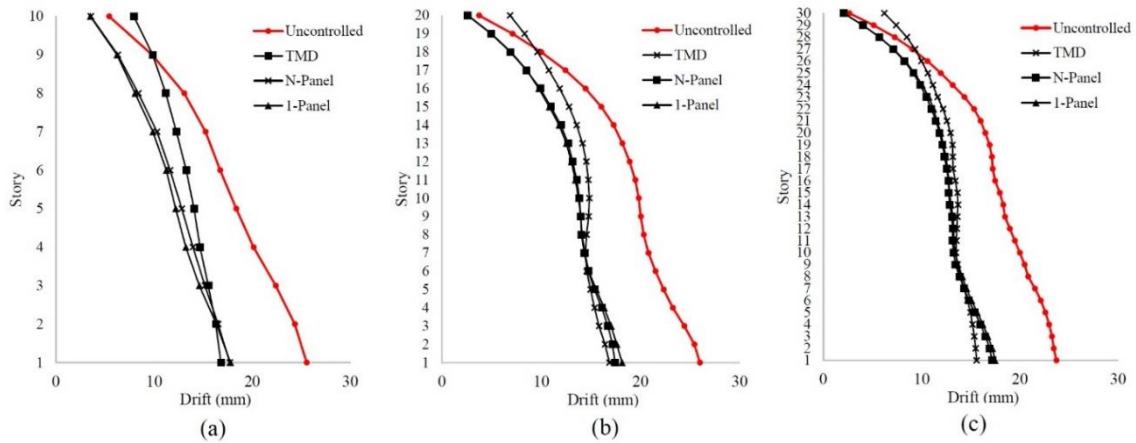

Figure 9. Maximum inter-story drift for primary structure and optimized models (a) 10-story model (b) 20-story model (c) 30-story model

Figure 10 shows the root-mean square average inter-story drift optimization for PMD N-Panel configuration. The blue dots shown are the minima in the respective systems.

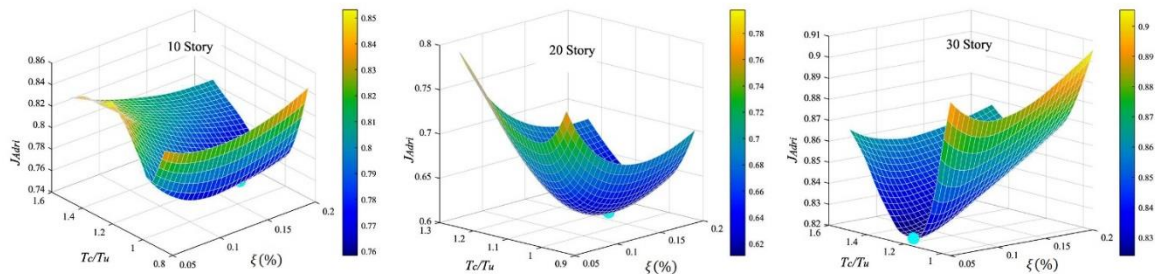

Figure 10. Variation of optimum parameters with respect to average drift objective function for N-Panel PMD model

Table 5 shows optimum values of the TMD, N-Panel, and 1-Panel PMD systems in three buildings included in the numerical example. All systems showed improvements in reducing

response over uncontrolled model, and the N-Panel configuration presented the largest improvements.

Table 5. Identified optimum parameters obtained by drift-based optimization

Model	10 Story				20 Story				30 Story			
	MR_{opt}	T_{opt}	ζ_{opt}	Red.(%)	MR_{opt}	T_{opt}	ζ_{opt}	Red.(%)	MR_{opt}	T_{opt}	ζ_{opt}	Red.(%)
TMD	10	1.05	20	26.03	20	2.1	20	23.15	20	3.15	20	24.76
N-Panel	20	1.01	16.3	28.99	20	1.98	9.9	28.16	20	3.47	8.7	24.83
1-Panel	20	0.97	13.6	28.61	20	2.03	9.9	27.78	20	3.45	8.3	23.8

Figure 11 shows the optimal values of drift objective function with respect to MR, for PMDs and TMD models. The results of drift optimization show that with increasing the panel MR, the structure response decrease and also the N-Panel system with 20% mass ratio is the most efficient Model. Also, it is observed in Figure 11 that in tall buildings the form of the TMD response diagram is closer to the response of PMD models and the optimal response is obtained at higher MR values. The optimal values of the 1-Panel layout have higher values, but they follow almost the same pattern as the N-Panel layout.

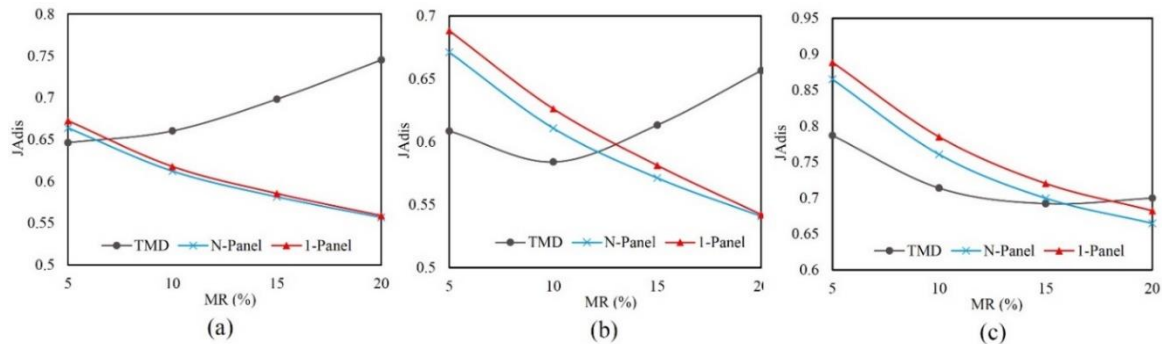

Figure 11. Optimum values of drift objective function for different MRs (a) 10-story model (b) 20-story model (c) 30-story model

Observations suggest that both PMD layouts can be considered as a reasonable solution to decrease engineering demand parameter for multi-story frame buildings without significantly compromising efficiency.

5. CONCLUSIONS

This article studies the feasibility and potential of passive control systems consisting in peripheral mass with damping connectors subjected to seismic excitation in tall buildings. The PMD system is examined in linear elastic shear-building models with 10, 20 and 30 stories with different fundamental periods. Two PMD system layouts have been investigated, each consisting of independent panels coupled to the main structure by elastic connections with viscous damping. Particle Swarm Optimization (PSO) algorithm used in order to minimize the objective function which the root-mean square (RMS) of the last story displacement,

acceleration and inter-story drift responses of the main structure.

The optimization approach is developed to select the parameters of the PMD models that minimize the structural response to the maximum extent possible. The effectiveness of the PMDs for reducing the structural response of the tall building is discussed in detail, and the PMD results compared with classic TMD and results available in uncontrolled model.

The PMD system's compatibility with various kinds of excitations has also been explored. The results show that optimizing the PMD system based on a single earthquake record does not produce robust results, whereas average optimization, which takes into account multiple events, allows identifying a PMD design that, while not reaching the optimum for each individual case, is fruitful for any seismic excitation.

The results of the analyses indicate that the use of both PMD and TMD systems helps to reduce the structural response. On average, the PMD system with N-Panel layout reduces displacement objective functions about 42% of the total reduction, whereas the TMD system with reduces about 37%. Also, the optimized model demonstrated that facade panels at the low MR can provide a building with multiple inherent mass dampers without the weight restrictions of common TMDs.

Based on the results of the case-study structures examined in this work, multiple-panel layouts appear to be more successful and adaptable. According to the optimal inter-story drift and top-level displacement and acceleration demands on the entire building, and taking to account structural and architectural constraints, 20% MR has the best possible response of the PMD technique. The simplified model for the analysis of a building structure with PMD system does not take into account the stiffness and damping characteristics of the facade, which may be the main reason for the similarity of the results of different layouts to each other. It is clear that with the variation of the facade type, the stiffnesses of the facade system on the structural system also varies.

Future research in this area should focus on optimizing the mass and arrangement of facade panels along the height of a building. The efficiency of the PMD system in structural models with nonlinear seismic behavior should also be investigated. For building layouts with imperfections in both plan and elevation, the influence of torsional reactions generated by out of phase movements of facade panels should be examined. The performance of the PMD system should also be investigated using a full three-dimensional building model with biaxial excitation. Research into active control strategies for the PMD system, while considering the specifications of the facade and how it is distributed in the height of the building, are ongoing.

REFERENCES

1. Madhekar S, Matsagar V. *Passive Vibration Control of Structures* (1st ed.), CRC Press 2022.
2. Li A. *Vibration control for building structures*, Springer International Publishing 2020.
3. Elias S, Matsagar V. Research developments in vibration control of structures using passive tuned mass dampers, *Annu Rev Control*. 2017; **44**: 129-156.
4. Naderpour H, Kiani A, Kheyroddin A. Structural control of RC buildings subjected to near-fault ground motions in terms of tuned mass dampers, *Sci. Iran* 2020; **27**(1): 122-

- 133.
5. Yanhui L, Kan W, Oya M, Huating C, Ping T. Experimental and numerical studies on the optimal design of tuned mass dampers for vibration control of high-rise structures, *Eng. Struct.* 2020; **211**: 110486.
 6. Kaveh A, Fahimi Farzam M, Maroofiazar R. Comparing H2 and H ∞ algorithms for optimum design of tuned mass dampers under near-fault and far-fault earthquake motions, *Period. Polytech.: Civ. Eng.* 2020; **64**(3): 828-844.
 7. Kaveh A, Rezazadeh Ardebili S. A comparative study of the optimum tuned mass damper for high-rise structures considering soil-structure interaction, *Period. Polytech.: Civ. Eng.* 2021; **65**(4): 1036-1049.
 8. Frahm H. Device for damping vibration of bodies., *U.S. Patent* 1911; No. 989,958.
 9. Den Hartog JP. *Mechanical Vibrations*, New York. McGraw-Hill 1956.
 10. Arfiadi Y, Hadi M. Optimum placement and properties of tuned mass dampers using hybrid genetic algorithms, *Int. j. optim. civ. eng.*, 2011; **1**(1):167-187.
 11. Mohebbi M, Alesh Nabidoust N. The capability of optimal single and multiple tuned mass dampers under multiple earthquakes. *Int. j. optim. civ. eng.* 2018; **8** (3): 469-488.
 12. Kamgar R, Khatibinia M, Khatibinia M. Optimization criteria for design of tuned mass dampers including soil-structure interaction. *Int. j. optim. civ. eng.* 2019; **9** (2): 213-232.
 13. Kaveh A, Mohammadi S, Khadem Hosseini O, Keyhani A, Kalatjari VR. Optimum parameters of tuned mass dampers for seismic applications using charged system search, *IJST, Transact Civil Eng.* 2015; **39**(C1): 21-40.
 14. Kaveh A, Javadi SM., Mahdipour MR. Optimal structural control of tall buildings using tuned mass dampers via chaotic optimization algorithm, *Structures* 2020; **28**: 2704-2713.
 15. Ozturk B, Cetin H, and Aydin E. Optimum vertical location and design of multiple tuned mass dampers under seismic excitations, *Structures* 2022; **41**: 1141-1163.
 16. Lu Zh, Liu X, Ma N, Zhou M. Multi-objective optimization and seismic performance verification of multiple tuned impact dampers for nonlinear benchmark building, *Structures* 2022; **41**: 1672-1686.
 17. Samali B, Abtahi P. Evaluation of the effect of smart facade systems in reducing dynamic response of structures subjected to seismic loads, *Earthq. Struct.* 2016; **11**(6): 983-1000.
 18. Knaack U, Klein T, Bilow M, Auer T. *Facades: Construction Principals*, Birkhäuser, Berlin 2014.
 19. Memari AM, Solnosky R, Hu C. Multi-Disciplinary Characteristics of Double-Skin Facades for Computational Modeling Perspective and Practical Design Consideration, *Buildings* 2022; **12**(10): 1576.
 20. Moon KS. Tall building motion control using double skin facades, *J. Archit. Eng.* 2009; **15**(3): 84-90.
 21. Moon KS. Integrated damping systems for tall buildings: tuned mass damper/double skin facade damping interaction system, *The Struct. Design Tall Spec. Build* 2016; **25**: 232-244.
 22. Fu TS, Zhang R. Integrating double-skin facades and mass dampers for structural safety and energy efficiency, *J. Archit. Eng* 2016; **22**(4):189-202.
 23. Palmeri A, Barone G, Khetawat A. Passive control of building structures using double-skin facades as vibration absorbers, *Proc, Fifteenth Int. Conf. Civil, Struct. Environ. Eng.*

- Comput.*, Prague, Czech Republic 1–12, 2015.
24. Anajafi H, Medina R. Comparison of the seismic performance of a partial mass isolation technique with conventional TMD and base-isolation systems under broad-band and narrow-band excitations, *Eng Struct* 2018; **158**: 110-123.
 25. Pipitone G, Barone G, Palmeri A. Optimal design of double-skin facades as vibration absorbers, *Struct Control Hlth* 2017; **25**(2): 189–204.
 26. Zhang Y, Schauer T, Bleicher A. Optimized passive/semi-active vibration control using distributed-multiple tuned facades damping system in tall buildings, *J. Build. Eng.* 2022; **52**: 104416.
 27. Kennedy J, Eberhart R. Particle swarm optimization, *Proceeding of IEEE International Conference on Neural Networks* 1995; **4**: 1942–1948.
 28. Talatahari S, Khalili E, Alavizadeh S. Accelerated particle swarm for optimum design of frame structures, *Math. Probl. Eng* 2013.
 29. Shojaee S, Arjomand M, Khatibinia M. A hybrid algorithm for sizing and layout optimization of truss structures combining discrete PSO and convex approximation, *Int. j. optim. civ. eng.* 2013; **3** (1) :57-83.
 30. Alimollaie S, Shojaee S. Optimal design of arch dams by combining Particle Swarm Optimization and group method of Data Handeling. *Int. j. optim. civ. eng.* 2017; **7** (4) :493-514.
 31. Dwrick DJ. Earthquake Resistant Design and Risk Reduction, *2nd ed.* Wiley. Chichester. United Kingdom 2009.
 32. Fahimi Farzam M, Kaveh A. Optimum design of tuned mass dampers using colliding bodies optimization in frequency domain, *IJST, Transact Civil Eng.* 2020; **44**:787–802.
 33. Gerges RR, Vickery BJ. Optimum design of pendulum-type tuned mass dampers, *Struct. Design Tall Spec. Build* 2005; **14**(4): 353-368.